

U.S. ARMY CORPS OF ENGINEERS 24 - HOUR MOTORBOAT TRAINING TESTING AND LICENSING MANUAL

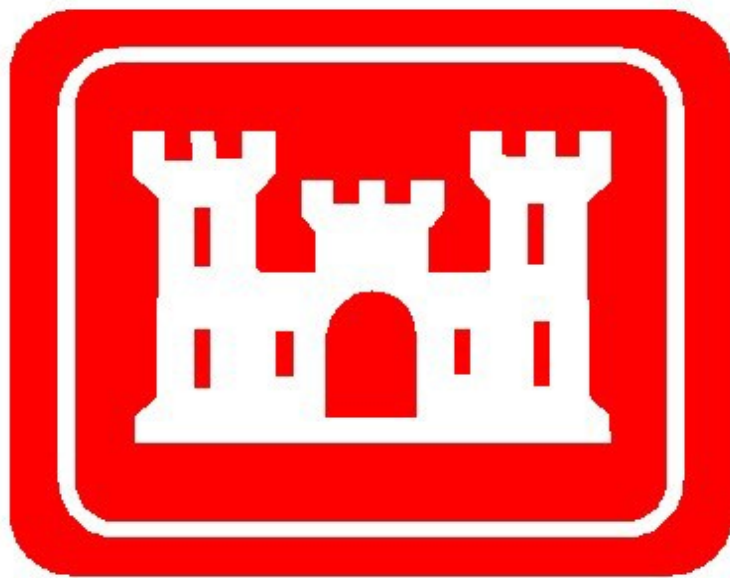

U.S. Army Corps of Engineers 24-Hour Motorboat
Training Testing and Licensing Manual

Table of Contents

<u>Activity</u>	<u>Location</u>	<u>Tab</u>
Course Agenda	Classroom	
Policy, Introduction and Safety Briefing	Classroom	1
Boats/Personal Watercraft and Boat Maintenance	Classroom/Practical	2
Trailer and Trailer Maintenance Launching and Retrieving	Classroom/Practical	3
Rules of the Road & Aids to Navigation	Classroom	4
Required Safety Equipment	Classroom	5
Fire Suppression	Classroom/Practical	6
Emergency Procedures	Practical	7
Boat Orientation/Marlinspike	Classroom/Practical	8
Boat Operators Inspection Checklist	Practical	9
Course Maneuvering	Practical	10
Towing and Anchoring	Practical	11
Course Evaluation	Classroom	12

COURSE AGENDA

24-hour Motorboat Operator Training Manual

The following agenda will be used by U.S. Army Corps of Engineers (USACE) to train employee operators of boats/vessels less than 26 feet in length. It is not necessary, but recommended, that course days run consecutively. The course schedule can be altered to meet local requirements as long as the subjects listed below are included in the total curriculum.

DAY 1

0800 Welcome, Introduction, Safety Briefing and Pretest
0900 Required Safety Equipment
1000 Change into Swimwear
1015 PFD Swim, Land Based Rescue
1130 Lunch
1230 Boat and Boat Maintenance
1315 Trailing/Trailer Maintenance
1415 Rules of the Road & Aids to Navigation
1515 Marlinespike
1600 Fire Suppression
1700 END

DAY 2

0800 Trailing
0900 Launching and Retrieving
1000 Close Quarter Maneuvering and Docking
1100 Lunch
1200 Maneuvering Courses
1500 Anchoring & Towing
1600 Water Based Emergency Procedures
1700 END

DAY 3

0800 Trailing, Launching and Retrieving
0900 Close Quarter Maneuvering and Docking
1000 Maneuvering Courses
1200 Lunch
1300 Maneuvering Course Test
1400 Pull Buoy Course and Recover Boats
1500 Written Post Test/Marlinespike Test
1630 Review/Questions
1700 END

The following agenda allows students to travel to and from their duty stations the first and last day of the training

DAY 1

1230 Welcome, Introduction, Safety Briefing and Pretest
1330 Required Safety Equipment
1430 Boat and Boat Maintenance
1530 Trailering/Trailer Maintenance
1600 PFD Swim, Land Based Rescue
1700 END

DAY 2

0800 Rules of the Road & Aids to Navigation
0900 Marlinespike
0930 Fire Suppression
1030 Trailering
1130 Lunch
1230 Launching and Retrieving
1330 Close Quarter Maneuvering and Docking
1430 Boat Handling Familiarization
1530 Maneuvering Courses
1700 END

DAY 3

0800 Trailering, Launching and Retrieving
0900 Close Quarter Maneuvering and Docking
1000 Maneuvering Courses
1200 Lunch
1300 Anchoring & Towing
1400 Water Based Emergency Procedures
1500 Maneuvering Courses
1700 END

DAY 4

0800 Maneuvering Course Test
0900 Pull Buoy Course and Recover Boats
1000 Written Post Test/Marlinespike Test
1130 Review/Questions
1200 END

Tab 1 - Policy, Introduction and Safety Briefing

24-hour Motorboat Operator Training Manual

I. Introduction.

A. ER 385-1-91 requires all U.S. Army Corps of Engineer (USACE) employees who operate USACE vessels less than 26 feet long to complete a 24-hour Motorboat Operator Training course and be licensed prior to official operation of the USACE vessel.

B. Purpose.

1. To validate that Corps personnel operate boats in a safe and prudent manner and in accordance with recognized Federal, state, local and USACE laws and standards.

2. To validate the operation of boats at safe speed and that operators have the skills and knowledge necessary to obtain and maintain their motorboat operator's license.

3. To validate that Corps motorboat operators know the proper rescue techniques, to include self-rescue and have the ability to swim 100 yards in a personal flotation device (PFD).

II. Course Content. The class will cover:

A. Activity Hazard Analysis with Risk Assessment Code.

B. Required safety equipment.

C. Boats and boat maintenance.

D. Trailering and trailer maintenance.

E. Rules of the Road and Aids to Navigation.

F. Emergency procedures to include rescue, fire suppression, and towing.

G. Docking and alongside maneuvers.

H. Serpentine, Slalom, Star and Emergency Stop maneuvering courses.

III. Course Safety.

A. PFD's will be worn at all times on or near the water (No Exceptions).

B. In-water participation shall be voluntary for all students, but is a requirement for completing the course.

C. Participants must pass a 100-yard swim test while wearing a PFD.

D. Participants must be able to self-rescue themselves back into the boat.

E. All vessels shall have on board all equipment required by U.S.Coast Guard, state, and EM 385-1-1.

F. All boat operations will be done at a safe and controlled speed, under the direction of an instructor.

G. There will be one instructor and one student onboard during the emergency stop maneuvering exercise.

H. Engine kill switches will be tested prior to any boat operations getting underway.

I. Engine kill switch lanyards will be worn at all times by boat operators when boats are underway.

USACE Small Boating Policy

ER 385-1-91, Training, Testing and Licensing of Small Boat Operators.

Operators of USACE vessels, less than 26 feet in length, will successfully complete a 24-hour training class and be licensed prior to official operation of a USACE vessel. Licensed operators will complete an 8-hour refresher class every five years to retain the license.

Motorboat License Examiners and operators will be trained to be fully knowledgeable of prescribed safety procedures including the use of all equipment and/or tools necessary to safely perform assigned tasks and be capable of swimming 100 yards with a Personal Flotation device (PFD).

EM 385-1-1, Safety and Health Requirements Manual

01.A.15a. An Activity Hazard Analysis (AHA) shall be prepared and documented for each USACE activity as warranted by the hazards associated with that activity. Typically, an AHA shall be prepared for all field, laboratory, industrial and maintenance activities.

01.A.15d. Work shall not begin until the AHA with Risk Assessment Code (RAC) for the work activity has been discussed with all engaged in the activity in a job pre-brief.

A sample AHA with RAC is included at the end of this tab. Districts must add any site specific information and hazards to the AHA for each training course. The AHA must be incorporated as part of the training curriculum and reviewed daily during training to accommodate changing conditions or activities.

19. F.05. All motorboat operators shall complete and document the following training:

- a. A boating safety course meeting the criteria of the United States Coast Guard Auxiliary, National Association of Safe Boating Law Administrators (NASBLA), or equivalent;
- b. Motorboat handling training based on the type of boats they will operate, provided by qualified instructors (in-house or other). Operators must pass a written and operational test;
- c. Current United States Coast Guard (USCG) licensed personnel are exempt from the boating safety training, but they shall complete the written exam and operational test;
- d. Government employees shall complete a USACE-approved 24-hour initial boating safety course and refresher as prescribed in ER 385-1-91.

Activity Hazard Analysis (AHA)

Activity/Work Task: Boat Operators License Training Course	Overall Risk Assessment Code (RAC) (of the highest hazard):	M																																							
Project Location:	Risk Assessment Code (RAC) Matrix <table border="1" style="margin: auto; border-collapse: collapse;"> <tr> <td colspan="2"></td> <th colspan="5" style="padding: 5px;">Probability</th> </tr> <tr> <td colspan="2"></td> <th style="padding: 5px;">Frequent</th> <th style="padding: 5px;">Likely</th> <th style="padding: 5px;">Occasional</th> <th style="padding: 5px;">Seldom</th> <th style="padding: 5px;">Unlikely</th> </tr> <tr> <th rowspan="4" style="writing-mode: vertical-rl; transform: rotate(180deg); padding: 5px;">Severity</th> <th style="padding: 5px;">Catastrophic</th> <td style="text-align: center; background-color: red; color: white; padding: 5px;">E</td> <td style="text-align: center; background-color: red; color: white; padding: 5px;">E</td> <td style="text-align: center; background-color: orange; padding: 5px;">H</td> <td style="text-align: center; background-color: orange; padding: 5px;">H</td> <td style="text-align: center; background-color: yellow; padding: 5px;">M</td> </tr> <tr> <th style="padding: 5px;">Critical</th> <td style="text-align: center; background-color: red; color: white; padding: 5px;">E</td> <td style="text-align: center; background-color: orange; padding: 5px;">H</td> <td style="text-align: center; background-color: orange; padding: 5px;">H</td> <td style="text-align: center; background-color: yellow; padding: 5px;">M</td> <td style="text-align: center; background-color: green; padding: 5px;">L</td> </tr> <tr> <th style="padding: 5px;">Marginal</th> <td style="text-align: center; background-color: orange; padding: 5px;">H</td> <td style="text-align: center; background-color: yellow; padding: 5px;">M</td> <td style="text-align: center; background-color: yellow; padding: 5px;">M</td> <td style="text-align: center; background-color: green; padding: 5px;">L</td> <td style="text-align: center; background-color: green; padding: 5px;">L</td> </tr> <tr> <th style="padding: 5px;">Negligible</th> <td style="text-align: center; background-color: yellow; padding: 5px;">M</td> <td style="text-align: center; background-color: green; padding: 5px;">L</td> <td style="text-align: center; background-color: green; padding: 5px;">L</td> <td style="text-align: center; background-color: green; padding: 5px;">L</td> <td style="text-align: center; background-color: green; padding: 5px;">L</td> </tr> </table>				Probability							Frequent	Likely	Occasional	Seldom	Unlikely	Severity	Catastrophic	E	E	H	H	M	Critical	E	H	H	M	L	Marginal	H	M	M	L	L	Negligible	M	L	L	L	L
			Probability																																						
			Frequent	Likely	Occasional	Seldom	Unlikely																																		
Severity			Catastrophic	E	E	H	H	M																																	
			Critical	E	H	H	M	L																																	
	Marginal	H	M	M	L	L																																			
	Negligible	M	L	L	L	L																																			
Contract Number:																																									
Date Prepared:																																									
Prepared by (Name/Title):																																									
Reviewed by (Name/Title):																																									
Notes: (Field Notes, Review Comments, etc.)	<p>Step 1: Determine and enter RAC codes for each "Hazard" with safety "Controls" (E, H, M, or L)</p> <table border="1" style="width: 100%; border-collapse: collapse;"> <tr> <td style="padding: 5px;"> "Probability" is the likelihood to cause an incident, near miss, or accident and identified as: Frequent, Likely, Occasional, Seldom or Unlikely. </td> <td style="text-align: center; padding: 5px;">RAC Chart</td> </tr> <tr> <td style="padding: 5px;"> "Severity" is the outcome/degree if an incident, near miss, or accident did occur and identified as: Catastrophic, Critical, Marginal, or Negligible </td> <td style="text-align: center; background-color: red; color: white; padding: 5px;">E = Extremely High Risk</td> </tr> <tr> <td style="padding: 5px;"></td> <td style="text-align: center; background-color: orange; padding: 5px;">H = High Risk</td> </tr> <tr> <td style="padding: 5px;">Step 2: Use the highest individual RAC of the Hazards + Controls below as the overall RAC for the Activity, and enter at the top of the AHA sheet.</td> <td style="text-align: center; background-color: yellow; padding: 5px;">M = Moderate Risk</td> </tr> <tr> <td style="padding: 5px;"></td> <td style="text-align: center; background-color: green; padding: 5px;">L = Low Risk</td> </tr> </table>		"Probability" is the likelihood to cause an incident, near miss, or accident and identified as: Frequent, Likely, Occasional, Seldom or Unlikely.	RAC Chart	"Severity" is the outcome/degree if an incident, near miss, or accident did occur and identified as: Catastrophic, Critical, Marginal, or Negligible	E = Extremely High Risk		H = High Risk	Step 2: Use the highest individual RAC of the Hazards + Controls below as the overall RAC for the Activity, and enter at the top of the AHA sheet.	M = Moderate Risk		L = Low Risk																													
"Probability" is the likelihood to cause an incident, near miss, or accident and identified as: Frequent, Likely, Occasional, Seldom or Unlikely.	RAC Chart																																								
"Severity" is the outcome/degree if an incident, near miss, or accident did occur and identified as: Catastrophic, Critical, Marginal, or Negligible	E = Extremely High Risk																																								
	H = High Risk																																								
Step 2: Use the highest individual RAC of the Hazards + Controls below as the overall RAC for the Activity, and enter at the top of the AHA sheet.	M = Moderate Risk																																								
	L = Low Risk																																								
Job Steps	Hazards	Controls	RAC																																						
1. Boat Operations A) Maneuvering Courses (serpentine, slalom, emergency stop, star)	1. Personnel 2. Drowning 3. Collisions 4. Falls Overboard 5. Fires/Explosions 6. Sun/Heat 7. Dehydration 8. Eye Fatigue 9. Dust/Debris/Material in Eye 10. Damaged/Sinking Vessel 11. Entanglement in Lines	1. The emergency stop maneuvering course shall be conducted with one instructor and one student on each vessel 2. Wear Personal Flotation Device (PFD). Know location and proper use of lifesaving devices (throw ring, throw bag, reach poles, ladder, cargo net) 3. Follow and obey boating rules/laws, recognize aids to navigation, maintain safe speeds, keep proper lookout 4. Wear PFD, know proper rescue procedures and wear proper footwear to maintain balance and footing. Make sure kill switch is operational and lanyard is attached to operator. Pay close attention to all other boats operating on maneuvering courses. 5. Follow proper venting and starting procedures. Know location of fire extinguisher and proper suppression techniques. 6. Wear proper clothing/hat to limit sun exposure. Use sunscreen and drink plenty of water. 7. Rehydrate with water/Gatorade 8. Wear proper eyewear/sunglasses 9. Wear proper eye protection 10. Obey navigation rules and heed weather warnings. Get to safe harbor as soon as possible. Stay with vessel until rescue. Wear PFD. 11. Keep vessel deck clear and properly coil or stow dock lines. Avoid pinch points and stay clear of lines under strain.	L M L M L L L L L L																																						

<p>5. Using Auto Inflatable PFD's</p>	<p>1. General</p> <p>2. PFD Worn Improperly or Improperly Assembled</p> <p>3. PFD damaged from storage</p> <p>4. Drowning</p>	<p>1. Employees must be 16 years of age and weigh at least 90lbs to wear this PFD. Employee must have water tested PFD prior to everyday use and must be trained in the use, maintenance, care, storage and inspection as per manufacturer's instructions.</p> <p>2. Employees must follow manufacturer's instructions for wearing and properly installing re-charge kit. Verify indicator gauge reads "green".</p> <p>3. PFD must be thoroughly inspected by disassembling PFD and manually inflating bladder to check its integrity. Inspect arming mechanism for damage. Any deficiencies must be corrected before the PFD can be put back in service.</p> <p>4. Employees wearing this PFD must have basic ability to tread water and be physically able to swim. Employee must be trained in the manual operation of this PFD should automatic inflation fail.</p>	<p>L</p> <p>L</p> <p>L</p> <p>M</p>
<p>6. Using PFD's</p>	<p>1. General</p>	<p>1. Before use make sure PFD is in serviceable condition and is not ripped or torn and all buckles, zippers or other fasteners are working properly. Make sure PFD is the right size and type for the task at hand and fits snugly.</p>	<p>L</p>
<p>7. Self-Rescue</p>	<p>1. General</p>	<p>1. Employees must demonstrate ability to self-rescue themselves back into the vessel by one of four methods:</p> <ul style="list-style-type: none"> a. Cavitation Plate on vessel engine b. Chin bounce c. Stirrup d. Ladder 	<p>L</p>
<p>8. Victim Rescue</p>	<p>1. General</p>	<p>1. Employees must demonstrate ability to rescue a conscious and unconscious victim back to the vessel:</p> <ul style="list-style-type: none"> A. Conscious Victim – use rescue procedure of Talk-Reach-Throw-Go and elevate procedure to the proper step depending on circumstances. B. Unconscious Victim – use any means (throw ring, cargo net, dock lines, reach pole, etc. to get victim astride of the boat. If possible retrieve victim back into boat. If not possible secure victim astride vessel until help arrives. 	<p>M</p>
<p>9. Classroom Work</p>	<p>1. Eye Strain</p> <p>2. Tripping/ Slipping</p> <p>3. Electrical Shock</p> <p>4. Office Machinery</p>	<p>1. Provide proper lighting</p> <p>2. Maintain good housekeeping. Secure any loose cords to floor.</p> <p>3. Proper grounding and maintenance of equipment. Repair or replace any damaged cords, switches, etc. or remove from service.</p> <p>4. Heed and obey caution signs on machinery. Prevent jewelry, loose clothing and hair from getting caught in machine.</p>	<p>L</p> <p>L</p> <p>L</p> <p>L</p>

<p>10. Reserved</p>			
<p>Equipment to be Used</p>	<p>Inspection Requirements</p>	<p>Training Requirements & Competent or Qualified Personnel name(s)</p>	
<p>1. Motorboats less than 26' in length with outboard engines. 2. Corresponding trailer matched to the motorboat. 3. Pick-up trucks 4. Safety rescue devices such as throw rings, throw bags, reach poles, ladders, cargo net and lines, first aid kit. 5. Classroom equipment to include: computers, projector and copy machine.</p>	<p>1. Small Boat and Equipment Checklist from ER 385-1-91 2. Small Boat and Equipment Checklist from ER 385-1-91 3. Small Boat and Equipment Checklist from ER 385-1-91 4 & 5 Requirements vary to each particular piece of equipment as outlined in US Army Corps of Engineers Safety Manual EM 385-1-1 or as per manufacturer's instructions</p>	<p><u>Employees participating in this training must:</u></p> <ul style="list-style-type: none"> A. Have completed a NASBLA or equivalent boaters safety education course B. Be able to swim 100 yards with a PFD C. Be able to self-rescue themselves back into the vessel. D. Pass the written exam with a minimum score of 80% E. Be tethered to the kill switch via a lanyard when operating the vessel F. Wear a Type III or better inherently buoyant PFD G. Demonstrate the ability to handle the boat and operate correctly through the maneuvering courses H. Be able to trailer, launch and retrieve the boat I. Demonstrate the ability to correctly dock the boat J. Closed toed and closed heeled shoes will be worn during entire training including all water exercises <p><u>Boat License Examiners:</u></p> <ul style="list-style-type: none"> A. A minimum of two examiners are required to perform the 24 hour motorboat training course B. Must be trained and certified in CPR/First Aid/AED C. Option to use a second lanyard attached to the students kill switch lanyard when student is operating the vessel <p><u>Qualified Examiners:</u></p>	

Tab 2 - Boats/Personal Watercraft and Boat Maintenance

24-hour Motorboat Operator Training Manual

I. Introduction: Provide a general introduction to the parts of boat and motor.

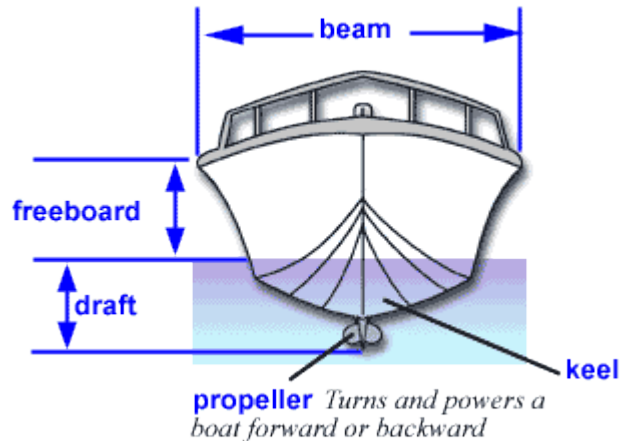
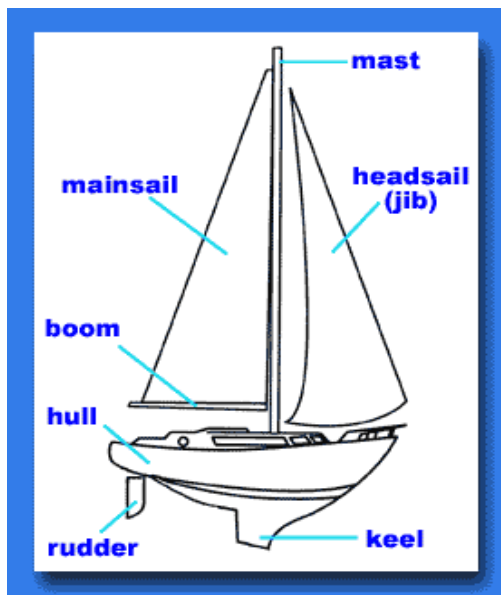
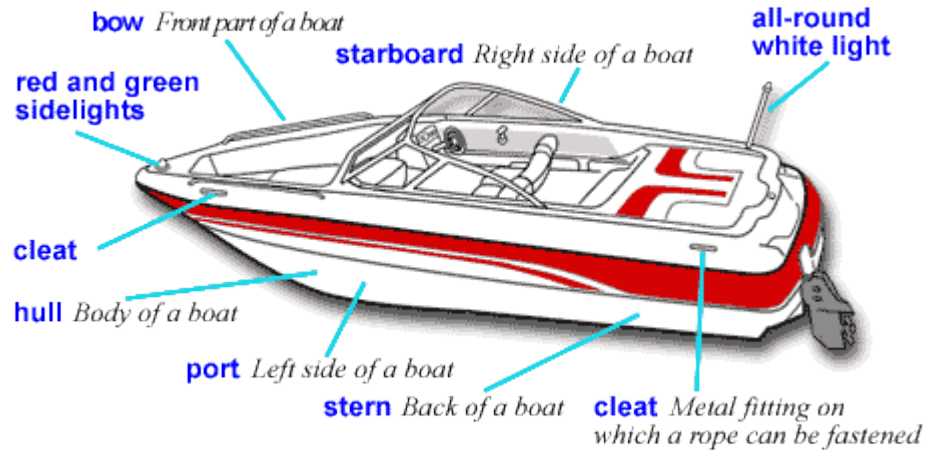

II. Hull.

A. Hulls are made of many different materials, which have distinct advantages and disadvantages.

1. Aluminum – these hulls are lightweight, but noisy and rough riding.
2. Fiberglass – these hulls are strong, light, relatively inexpensive, but are difficult to repair.
3. Steel – these hulls are strong, but very heavy. Steel hulls make for a slow boat.
4. Inflatable – these hulls are portable, but easily damaged.
5. Other types include wood, concrete, and synthetic fibers.

B. Types of hulls.

1. Displacement hulls move through the water. These hulls are slow but very stable. Boats with displacement hulls are designed to cut through the water with a minimum of propulsion. Most sailboats and large cruisers have displacement hulls to allow them to travel more smoothly through the water.

2. Planing hulls move on top of the water. These hulls are fast but less stable than a displacement hull. Boats with planing hulls are designed to rise up and glide on top of the water when enough power is supplied. Most small powerboats, including personal watercraft (PWC) have planing hulls allowing them to travel more rapidly across the water.

C. Hull shapes.

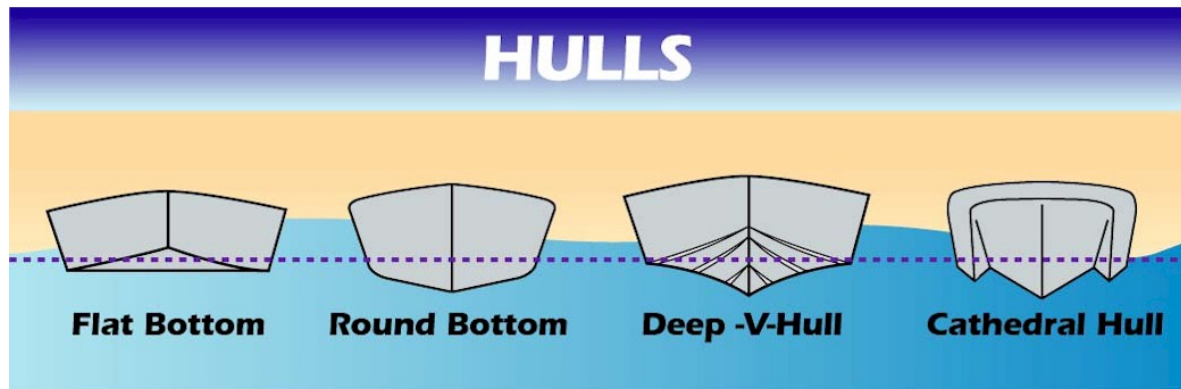

1. Flat Bottom. Flat bottom boats are typically small open boats such as johnboats. Flat-bottomed boats can easily get "on plane" or ride on top of the water at high speeds. Flat bottom boats are typically intended for use on calm waters such as ponds, small lakes, and slow rivers because they do not handle well in choppy or rough water, especially at planing speeds. Flat-bottomed boats are not very stable; caution should be used when moving around them.

2. Round Bottom. Round bottom boats almost "glide" through the water. Because round-bottomed boats are very efficient at moving through water, most cruising sail and powerboats have rounded hulls. Typically, round-hulled boats move at slow speeds.

3. Deep-V hull. "V-hulls" are designed to operate at high speeds and to "cut" through rough water. V-hulls are not as efficient as flat or round-bottomed boats, and need larger engines to move at similar speeds.

4. Cathedral hull. Cathedral or multi-hulls, are two or more hulls attached together. This combination of hulls allows for much more stability than what is found in other hull forms. The air pocket that is formed between the hulls may also provide lift, helping the boat get on plane more easily and increasing efficiency.

D. Maintenance.

1. The bottom of the boat must be kept clean to maximize the performance of the boat. A dirty hull will reduce speed and use excessive fuel.

2. All joints and seams in the hull should be checked regularly for cracks, signs of wear and leaks. The bilge should also be checked.

III. Engine (motor). Do not overpower your vessel by using a motor with a horsepower rating higher than the maximum stated on the boat's capacity plate.

A. Types of motors.

1. Inboard motors are mounted inside the hull's midsection or in front of the transom. An inboard on a boat is a four-stroke automotive engine adapted for marine use. The engine turns a drive shaft that runs through the bottom of the hull and is attached to a propeller at the other end. Steering of most inboard boats is controlled by a rudder behind the propeller.

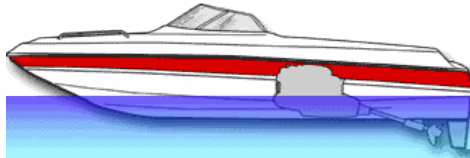

2. Outboard motors are a complete power unit, including an engine, gear case and propeller, mounted on the transom of the boat. Outboards range in size from under one horsepower (hp) to more than 300 hp. Outboards include electric trolling motors. Outboards have a higher horsepower-to-weight ratio than other engine types. Most outboards have separate fuel tanks that are either portable or built into the boat, although smaller motors have self-contained fuel tanks. Outboards are internal combustion engines. A growing number of outboard engines are of four-stroke design; but most are still 2-stroke engines, which require oil to be mixed with the fuel to properly lubricate the engine. Steering of outboard boats is controlled by a tiller steering wheel, which swivels the entire engine to direct propeller thrust.

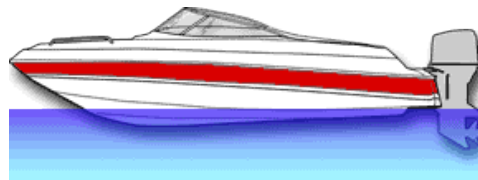

3. Inboard/Outboard (I/O) motors combine features found on both inboard and outboard engines. Stern drive motors are mounted inside the boat and attached through the transom to a drive unit, which resembles the lower section of an outboard. Stern drives are four-stroke automotive engines adapted for marine use. The engine turns a drive shaft that runs through the transom and is attached to a propeller at the other end. Steering is controlled by a drive unit that swivels like an outboard.



4. Jet Drive systems have the advantage of having no propeller to cause potential danger to people in the water and marine life. They are usually inboard engines that take in water, which flows through a pump powered by an impeller. The water is then discharged at high pressure through a nozzle that propels the boat forward. The nozzle swivels to provide steering to the boat. Most personal watercraft use jet drives.

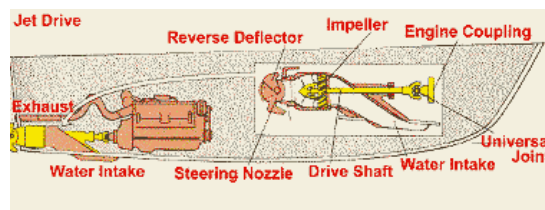

B. Fuel.

1. 4-Cycle engines use straight gasoline and have a separate oil reservoir, which should be checked regularly.

2. 2-Cycle engines utilize a mixture of gasoline and oil, i.e. 100:1 [1% oil] or 50:1 [2% oil]. Outboards are typically 2-Cycle engines though 4-Cycle engines are gaining popularity.

3. If your vessel has a permanently installed fuel tank, pour lubricant (oil) into tank with gasoline as the tank is filled.

4. Safety Warning: Gasoline is extremely flammable and highly explosive under certain conditions.

- a. Always mix fuel outdoors, never indoors.
- b. Never smoke or allow open flames or sparks nearby when mixing or refueling.
- c. Always stop motor before refueling.
- d. Remove portable tanks from boat when refueling.

C. Propeller. Boat motor and propeller match-up is important for proper operation.

1. Plastic propellers (props) are used in low horsepower situations. The blades tend to cup when operating. These props are less expensive than props made of other materials.

2. Aluminum props are standard equipment on many engines. They have good strength and corrosion resistance. Aluminum props can chip or bend if it strikes a submerged object. This bending or chipping can save drive components of the engine.

3. Stainless Steel props are the strongest, most effective props available. Stainless steel propellers are the most expensive props on the market. They are very good for use in deep water. This prop won't bend if it strikes an object, but this may transfer damage to other drive components of the engine.

4. The number stamped on the prop refers to the prop's diameter and pitch. Example: numbers 13x10 mean the prop has a 13-inch diameter and a 10-inch pitch.

a. Diameter is the distance across the circle described by the blade. As a rule, a slower turning, larger diameter propeller is more efficient than a faster turning, small diameter propeller.

b. Pitch is a product of the propeller's diameter and the rake of its blades and is the distance in inches the prop should travel forward in one revolution.

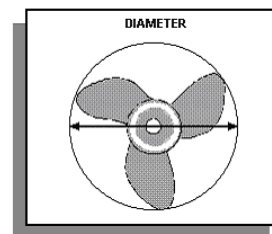

5. Boat/Prop Match up.

a. Find the recommended wide-open throttle (WOT) rpm range for your motor in your owner's manual.

b. Make several test runs to determine the maximum rpm and boat speed.

c. If the WOT rpm is too high; install the next larger pitch and retest.

d. If the WOT rpm is too low; install the next smaller pitch and retest.

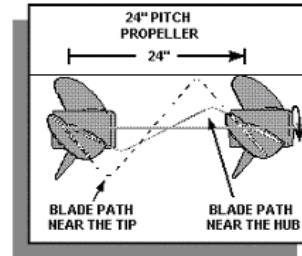

D. Routine motor maintenance. (Check owner's manual and shop manual for detailed procedures).

1. Grease all fittings and drive parts of the motor with proper lubricants.

2. Change lower unit (gear case) lubricants at least every 100 hours of operation or once each season, whichever occurs first.

3. Inspect spark plugs and clean or replace as necessary.

4. Check motor for loose hose connections, leaks or parts lying inside lower housing tray.

5. Propeller examination and replacement/installation. (Instructor should demonstrate how to change a propeller)

a. Remove and clean propeller if you find fish line wrapped around the shaft.

b. Replace propeller if damaged by being bent or a series of nicks is present. The unbalanced propeller could damage the engine.

E. Trouble Shooting.

1. Engine fails to start or engine loses power or stops while under way. (Engines are more likely not to start than to quit while running)

a. Out of gas, gas is old, or the fuel system is dirty.

b. Check the valves of a portable fuel tank and the fuel line from the tank to the engine. Be sure the line is properly connected to the tank and to the engine.

c. Check the battery connections.

d. Loose wire in the ignition circuit. Warning: The ignition system on an outboard system can cause a serious shock.

e. Fuel not reaching cylinders. Check the on/off valve and the fuel from the tank to the cylinders; check the fuel line under the engine cover; check the spark plugs to see if they are wet with fuel; if so, the engine may be flooded.

f. Overheated. If the engine is hot, the cooling system may be blocked or the water pump may be worn out. Do not try to start an overheated engine, let it cool first. Outboard engines have water pump indicators that discharge a steady stream of water when the water pump is operating properly.

- g. Fouled spark plug – clean or replace the spark plug.
 - h. Carburetor adjustment too lean or too rich.
 - i. Improper oil/fuel mixture.
 - j. Kill switch is disengaged.
2. Engine seems to run well but lacks power while under way:
- a. Improper mounting.
 - b. Incorrect tilt angle or improper load distribution.
 - c. Fouled propeller or lower unit.
 - d. Damaged propeller blades or bushing assembly.
 - e. Engine knock. Often caused by loose propeller or loose flywheel nut, by worn bearings, worn pistons, or by a broken engine mount spring. Generally, if the engine starts to knock, take it to a dealer.
 - f. Excessive water in bilge resulting in extra weight. Check for leak or drain plug.

Personal Watercraft (PWC)

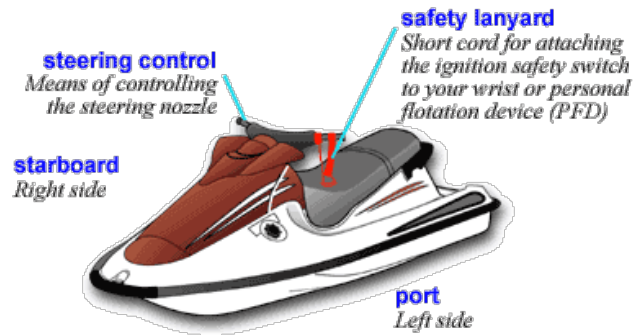

I. Introduction

A PWC is a small watercraft that uses an inboard jet drive as propulsion and is designed to be operated by sitting, standing or kneeling on rather than inside the vessel. The United States Coast Guard (USCG) includes personal watercraft in the group of inboard vessels less than 16 feet in length.

II. Requirements

PWCs are subject to all of the same laws and requirements of any other vessel plus the following specific laws.

- I. Each person riding on or being towed behind a PWC must wear a USCG approved Type I, II, III or V personal flotation device (PFD). It is advised that the PFD be approved for impact at high speeds.
- II. PWCs must be equipped with a fully operational self-circling device or a lanyard type ignition safety switch. The lanyard must be attached to the person, clothing or PFD of the operator.
- III. PWCs may not operate between sunset and sunrise.
- IV. PWCs must be operated at idle speed within certain distance of persons in the water, a non-moving vessel, a bridge and a dock or pier.
- V. It is illegal to jump the wake of another vessel unnecessarily close to the other vessel or when visibility around the other vessel is restricted.
- VI. It is illegal to chase, harass or disturb wildlife.

III. Operation

- a. PWCs are propelled by a jet drive where water is forced out under pressure through a steering nozzle. This jet of water is directed by the steering control.
- b. The most important thing to remember is that you must always have power in order to maintain control. Some newer models have steering control at idle but be familiar with the model you are operating.
- c. Always allow plenty of room for stopping. Even models with a braking system do not stop immediately. Plan your escape and give plenty of space between you and other vessels.
- d. A passenger on a PWC should never be seated in front of the operator.
- e. Make sure the water is at least 30 inches deep to prevent damage to the jet drive and damage to the environment.
- f. Know how to re-board your PWC if you fall off and know how to upright an overturned PWC. There are specific direction on how to roll a PWC as to not cause damage to internal parts. It is a good idea to practice this situation before and emergency.
- g. PWCs are very maneuverable and because of that can get into trouble fast. Always be aware of your surroundings and look over both shoulders before making turns.
- h. Read the operation manual of your PWC and become familiar with maintenance and operation before use. Pay particular attention to the electrical system to ensure there is no potential for electrical spark. Gas fumes can collect in the engine compartment and an explosion from the spark could occur.

Tab 3 - Trailering, Trailer Maintenance & Launching/Retrieving

24-hour Motorboat Operator Training Manual

I. Introduction. This module will provide a general introduction into trailer characteristics, trailer maintenance, safe towing and launching and retrieving. Choosing the correct trailer for the job requires knowing the load rating, load height, and what equipment is on the trailer

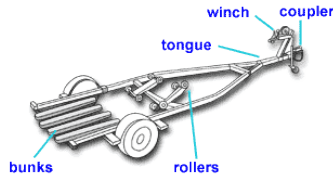

A. Load rating.

1. Check the manufacturer's specifications, which are on a plate attached to the trailer. If the weight of the boat and its engine is more than 90% of the recommended load capacity, buy the next larger trailer. This is because your gear (fuel, PFD's, anchors, lines, etc.) will increase the overall weight by at least 10%.

2. Trailers are classified by the maximum amount they may weigh when fully loaded.

Gross Vehicle Weight Rating

Class 1 - <2000 lbs.

Class 2 - 2001 to 3500 lbs.

Class 3 - 3501 to 5000 lbs.

Class 4 - > 5000 lbs.

B. Load height. Ensure that the boat is properly loaded onto the trailer to keep the center of gravity as low as possible. Extended mirrors on the towing vehicle may be necessary to ensure good visibility around and over the vessel. The height of the load will affect how easy the vessel is to launch and retrieve.

C. Equipment.

1. Hitches.



a. The trailer is attached to the towing vehicle by a trailer hitch. A socket on the front of the trailer drops over a ball on the back of the hitch and then locks down. These two parts must match in size. The ball size is determined by the class of trailer. The size rating will be stamped on the ball. On the trailer the size will be stamped on the coupler. The hitch should be permanently attached to the towing vehicle and should handle the load you are attempting to pull. Frame-mounted hitches reduce trailer swaying. If using a vehicle bumper mounted hitch, do not exceed the weight rating of the bumper.



b. Tongue weight is the weight the loaded trailer places on the towing hitch. The tongue weight should be 7 - 10% of the combined weight of the boat and trailer. If the tongue weight is too low, the trailer will fishtail at high speed. If the tongue weight is too high, it will drag down the rear of the tow vehicle and make steering difficult.

c. Safety chains should be a part of every hitch system. The chains should have a breaking strength of no less than the combined weight of the boat and trailer. Criss-cross the safety chains when attaching them to the towing vehicle.



2. The winch mechanism may utilize nylon straps or cable to secure the bow of the boat to the trailer. Additional tie down straps should also be available to secure the transom of the boat to the trailer.

3. Many trailers have electric or hydraulic brakes.

4. All trailers should be equipped with lights as required by law. These lights should be waterproof and mounted up high on the trailer if possible. It is a good idea to unplug the lights before backing the trailer into the water, but remember to plug them back in after the trailer is out of the water.

5. Many trailers utilize a motor support or transom saver to help support outboard engines and keep the engine from bouncing and cracking or breaking the transom.

6. All trailers have some type of bottom support on which the vessel rests and which helps support and distribute the weight of the vessel over the trailer. These supports may include carpet-covered wood runner and rubber rollers. Trailers may also be outfitted with a variety of side guides.

II. Choosing the correct tow vehicle for the job requires knowing the load rating and what equipment is available on the tow vehicle.

A. Check the manufacturer's load rating on the bumper and trailer ball. Ensure that you know how additional add on's, such as stabilizers, weight distribution hitches and drop down hitches, affects the load rating of the towing vehicle.

B. Equipment.

1. Hitch. See paragraph II.C.1.a. above

2. If a heavy trailer is to be pulled, you may need to add a cooler for crankcase oil and transmission fluid. Check the vehicle owner's manual to determine the maximum load that can be towed without modifications to ensure that you do not void the vehicle's warranty.

3. The towing vehicle should have sufficient horsepower to tow the weight of the trailer and boat.

Rule of Thumb:

Add the weight of the boat and trailer.

Knock off the last zero.

The remainder equals how many cubic inches of engine you need to adequately haul the load.

4. Make sure your side view mirrors are large enough to provide an unobstructed rear view on both sides of the vehicle.

5. Tires on the towing vehicle should be properly inflated with good tread.

III. Trailering the Load.

- A. Check tie down straps for security and proper operation.
- B. Ensure that the safety catch is securely attached to the bow of the vessel.
- C. Check the safety chains to ensure that they are criss-crossed under the tongue of the trailer. This will catch and cradle the tongue and prevent the tongue from dropping and hitting the pavement, which can lead to a potentially serious accident. Chains need to be long enough that they don't bind when turning, yet not so long that they drag on the roadway.
- D. Ensure that the hitch is properly and securely latched over the ball. Check to ensure that the safety pin or latch that locks the hitch onto the ball is in its proper position.
- E. Check to make sure that the transom saver (if used) and the tie down straps are properly secured.

IV. Driving Tips.

- A. Reduce normal driving speed when towing a trailer. The additional weight of the trailer makes it take longer to slow down. The increased length and width of the vehicle and trailer decreases visibility when changing lanes and makes it more difficult to make turns.
- B. Check your vehicle owner's manual to determine the best gear to use while towing.
- C. On long trips, pull over periodically to check the rigging, tires and bearings.

V. Trailer Maintenance.

- A. Check trailer brakes for proper operation before each trip.
- B. Check hydraulic fluid levels in brake reservoir.
- C. Grease wheel bearings with water resistant grease in accordance with manufacturer's specifications. It is a good idea to always carry an extra set of wheel bearings, a jack, and a lug wrench.
- D. Check trailer tires to ensure that they are properly inflated and that they are not dry rotted. You can protect against dry rot by use of preservative.
- E. Check bottom support bunks and guides to ensure that they are not cracked or splintered and that they are functioning properly.
- F. Check and lubricate the trailer winch. Ensure that the nylon webbing or cable is not cut, frayed or worn in any way.



VI. Launching and Retrieving Tips.

A. Check the weather conditions of the area where you will be boating before you leave to trailer to the area.

B. Prepare your vessel and trailer in the staging area (attach dock lines, fenders, load gear, unplug trailer lights, put in drain plugs, etc.) so as to not block ramp traffic.

1. Visually check the condition of the ramp.
2. Remove all straps EXCEPT the bow strap.
3. One person in vessel and one person in vehicle. Must communicate with each other
4. When boat operator is ready signal the driver.
5. Vehicle window must be down, remove seat belt, turn the radio off as well as anything else that will prevent clear and understandable communication between the driver and operator.
6. Back the boat and trailer down the ramp, until boat transom starts to float and keeping the tow vehicle's wheels out of the water.
7. Vehicle driver - apply emergency brake then put in park.
8. Boat operator - lower motor and start, allow to warm up.
9. Vehicle driver - unhook safety chain and bow strap and signal when ready.
10. When boat operator is ready, put foot on brake, release emergency brake and slowly back in to water.
11. Boat operator - reverse motor(s) and ease off trailer.
12. When ready, put vehicle in forward gear and slowly pull trailer out of water to the parking area.

C. Retrieving Tips.

1. Visually check the condition of the ramp.
2. Vehicle window must be down, remove seat belt, turn the radio off as well as anything else that will prevent clear and understandable communication between the driver and operator.
3. Back trailer down to proper depth.
4. Set emergency brake and put vehicle in park.
5. Exit vehicle and stand to side to aid guiding boat onto trailer.
6. Boat operator should trim up motor(s) and ease forward onto bunks.
7. Let boat settle and ease forward as dictated by the boats position on trailer.
8. When bow is a couple of inches from bow stop, hold in position and allow bow strap to be secured.
9. Vehicle driver - Winch boat up against the bow stop. Hook up safety chain.
10. When secure, communicate with boat operator.
11. Boat operator should turn off motor(s) and trim up.
12. When ready, put vehicle in gear, release emergency brake and slowly pull boat out of water to staging area.
13. Once in staging area plug in lights, check hitch connections, secure all loose items on boat, secure transom straps and transom saver (if applicable) remove drain plugs (if applicable) and recheck bow strap and safety chain.

Tab 4 - Rules of the Road & Aids to Navigation

24-hour Motorboat Operator Training Manual

I. Introduction. Why are there rules and aids to navigation?

A. To avoid collision. The most common type of boating accident is collision with another vessel. This is usually caused by an improper lookout.

B. To provide a safe route on the water. The second most common type of boating accident is collision with a fixed object.

II. How to keep from running into each other.

A. The most important rule is to avoid collision no matter who is in the right.

B. Determining if you are on a collision course.

1. A collision course is difficult to tell on the water, especially at night. Vessels are not confined to a lane like cars.

2. Constant bearing, decreasing range.

a. Sight in the other boat off your compass or any piece of equipment on your boat. If the other boat gets closer but is still in the same relative position to your boat, you may be on a collision course.

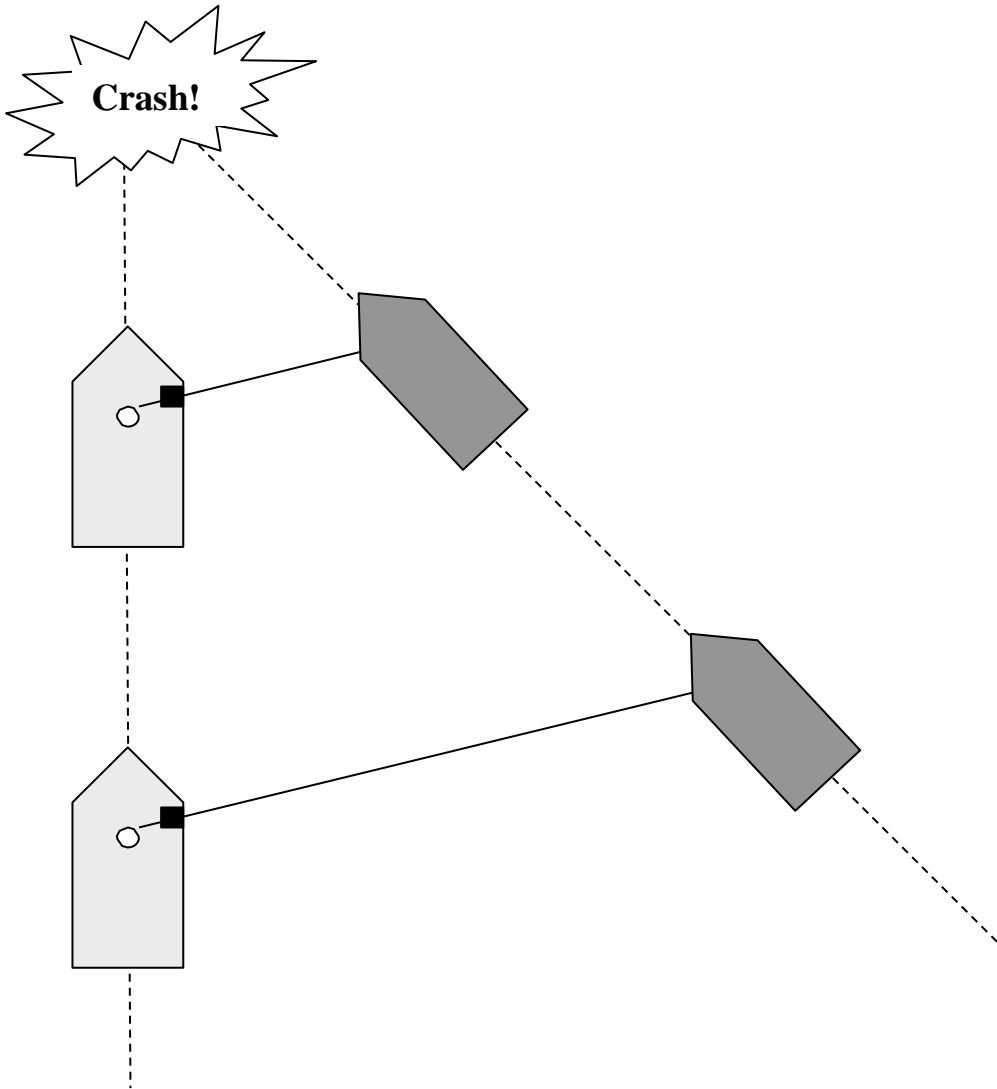

b. Sight in the other boat off of a tall object on the opposite shore (radio tower, tall tree, etc.). If the other boat gets closer but still has the same relative position to itself, you may be on a collision course.

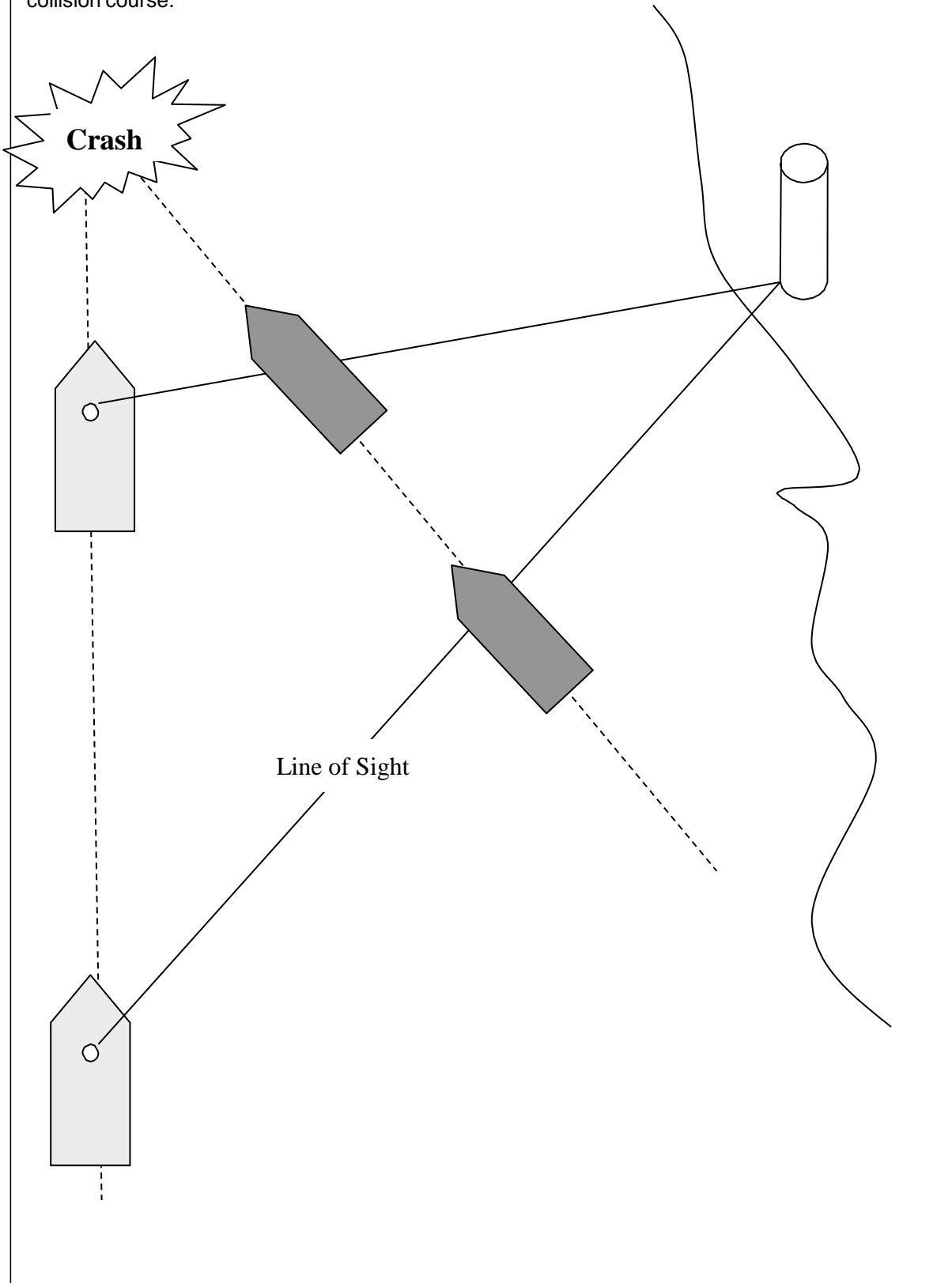

III. What to do when encountering another boat.

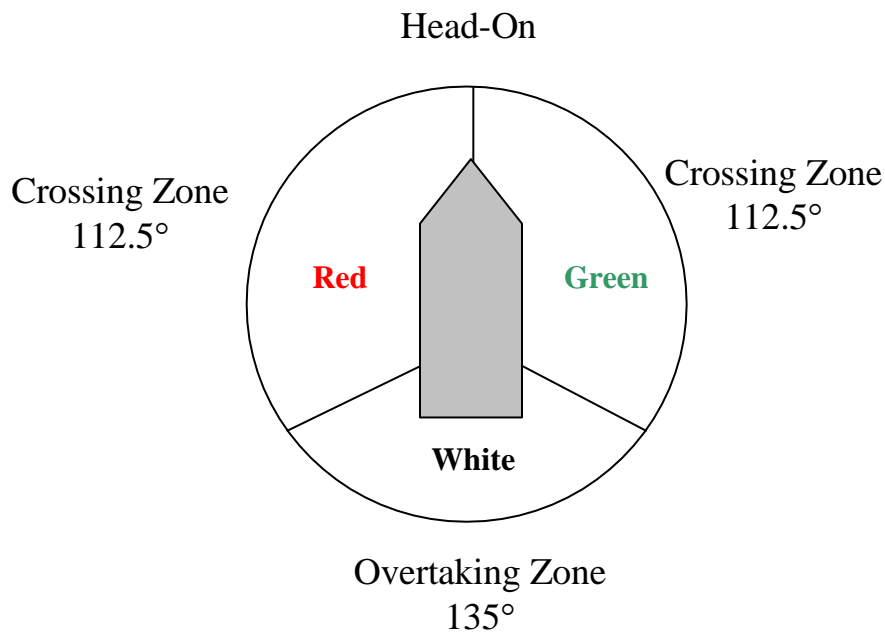

A. Head On – When two boats approach each other on opposite or nearly opposite courses.

1. Neither has the right-of-way.
2. Keep to the right (starboard).
3. May keep left (port) if both vessels are far enough apart so as to pass at a safe distance.

B. Crossing – When the course of two vessels will intersect.

1. A vessel coming at you from your starboard side is the stand-on vessel so you must give way. This is your danger zone.
2. A vessel coming at you from your port side SHOULD give way to you (don't count on it).
3. The crossing zone includes an arc of $112\frac{1}{2}$ degrees from dead ahead to slightly aft the beam.

C. Overtaking – When one vessel passes from behind or nearly from behind.

1. A vessel being overtaken is the stand-on vessel.
2. The overtaking zone includes an arc of 135 degrees across the stern.
3. If an overtaking vessel starts out in an overtaking zone and moves into the crossing zone, it is still considered an overtaking situation.

D. Lights as applied to meeting situations.

1. Memory Aid. The words "right", "starboard", and "green" all have more letters in them than their counterparts: "left", "port", and "red". Also, "left" and "port" each have four letters.
2. If you see red, green and white, you are in a head-on situation. Keep to starboard.
3. If you see red and white, it indicates a crossing situation and the other boat is the stand-on vessel

Meeting Head-on



Crossing Situation



4. If you see green and white, it indicates a crossing situation where you are the stand-on

5. If you see only the white stern light, you are overtaking another vessel and they are stand-on. But be careful! White only could also indicate a vessel at anchor or a vessel under oars.

6. If only red and/or green is visible without white, it indicates a sailboat.

7. Refer to reference manuals for additional light applications that may be used by various types of vessels in your local area.

8. Memory Aid. Think of vessel lights like a traffic light. Green means go and red means stop.

E. Certain vessels have priority. Priority order is as follows under **Inland Rules**.

1. Vessels not under command (runaway, adrift, abandoned boats).
2. Vessels restricted in their ability to maneuver because of size or draft (towboat, dredge, large ship, etc.).
3. Fishing vessel engaged in trawling but not trolling.
4. Sailboat under sail, or manually powered boats. A sailboat operating under power is considered a power vessel.
5. Power driven vessel underway.
6. A sea plane on the water.

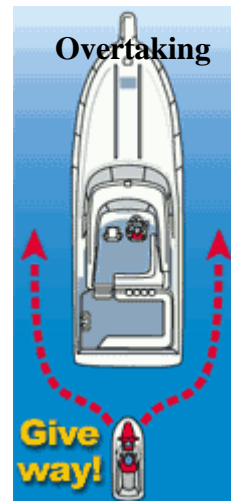

F. Whistles/horns.

1. These need to be used only when danger of collision exists. In reality, recreational vessels seldom use them.

2. Signals (inland rules).

- a. 5 short blasts – Danger, doubt, I do not understand.
- b. 3 short blasts – I am operating astern propulsion.
- c. 2 short blasts – I intend to leave you on my starboard side.
- d. 1 short blast – I intend to leave you on my port side.

e. 1 prolonged blast - 1) When approaching a bend or area of waterway where other vessels may be obscured by an intervening obstruction, 2) when leaving a dock or berth, or 3) at two-minute intervals for power driven vessels underway in restricted visibility.

f. Under inland rules, the other vessel answers with the same signal if in agreement.

3. Refer to reference manuals for local applications of inland or international rules, fog requirements, etc.

G. Visual Distress Signals.

- 1. See Equipment Requirements section.
- 2. Use anything you can to attract attention; waving arms, flashlights, etc.



IV. Aids to Navigation

A. Types of Aids: Instructors should present an overview of all types.

Buoys (floating aids): nuns; cans; bell/gong/whistle buoys; lighted buoys

Beacons (fixed aids): lighthouses; daybeacon; range markers.

B. Types of Applications: Lateral (red/green - defines the border of channels); Cardinal (black/yellow - indicates which side to pass a danger); Isolated Danger (shows obstacle position); Safe Water (deep water and beginning of a channel); Wreck; Regulatory (orange/white - information/regulation). Special Purpose (yellow - non-navigational, defining an area or pipeline, etc.); Ranges (line up on, staying in the channel).

C. Types of Navigation Systems: Instructor should focus on system(s) used in their district, but can introduce students to other types.

1. IALA (**International Association of Lighthouse Authorities**). IALA System A and IALA System B regulate navigational markings throughout most of the world. System A is generally used in the Eastern Hemisphere, while System B is generally used in the Western Hemisphere.

2. IALA System A. This system puts the red lateral buoys on the left side of the channel as a vessel is returning to port from seaward.

3. IALA System B. This system puts the red lateral buoys on the right side of the channel as a vessel is returning to port from seaward. This system and its variations are used in the Americas, Japan, Korea, and the Philippines.

D. U.S. Aids to Navigation (USATONS)

(Navigable Waters except Western Rivers and Intracoastal Waterway). Navigation aids in this lateral system are determined by their position with respect to the navigable channel, as the channels are entered and followed from seaward toward the head of navigation.

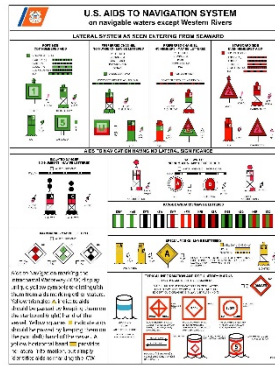

E. Intracoastal Waterway (ICW). The Intracoastal Waterway runs parallel to the Atlantic and Gulf Coasts. Unofficially, it begins at Manasquan River, NJ, which leads to Mile Zero at Norfolk, VA, then on to Brownsville, TX and the Mexican Border. Most aids to navigation on the ICW are conventional day beacons and buoys, but the real identifier is the yellow triangle or square. As you travel on the ICW from NJ to TX, triangles stay on your right (towards the mainland) and squares stay on your left (to sea).

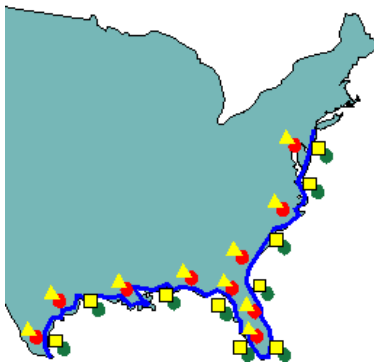

F. Western Rivers. This system is used on the Mississippi River and its tributaries above Baton Rouge, LA and on some other rivers

that flow toward the Gulf of Mexico. Red and green aids have no numbers or letters but may be accompanied by a mile marker. Right-descending bank = green aids; Left-descending bank = red aids. They also use crossing markers (on river bends, out-borders take the outside of the curve, in-borders take the inside curve).

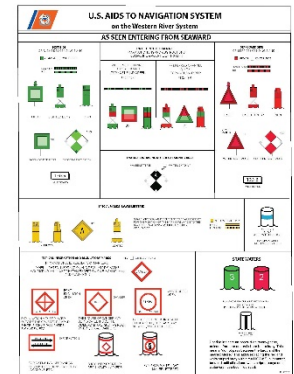
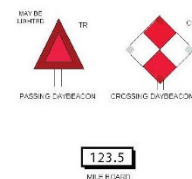

G. Uniform State Waterway Marking System (USWMS)

This system was replaced by the USATONS system in 2003. It was primarily used on lakes and other inland waterways not portrayed on nautical charts.

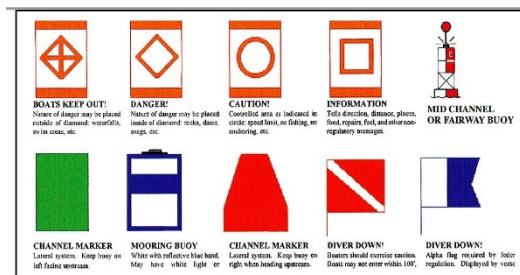

1. Tricks to remember: **Red – Right – Returning.**

2. Navigation charts: If applicable, Instructor should show examples and explain their use.



U.S. AIDS TO NAVIGATION SYSTEM

on navigable waters except Western Rivers

LATERAL SYSTEM AS SEEN ENTERING FROM SEAWARD

PORT SIDE ODD NUMBERED AIDS	PREFERRED CHANNEL NO NUMBERS--MAY BE LETTERED	PREFERRED CHANNEL NO NUMBERS--MAY BE LETTERED	STARBOARD SIDE EVEN NUMBERED AIDS
<p>GREEN LIGHT ONLY</p> <p>FLASHING (2) </p> <p>FLASHING </p> <p>OCCULTING </p> <p>QUICK FLASHING </p> <p>ISO </p>	<p>PREFERRED CHANNEL TO STARBOARD TOPMOST BAND GREEN</p> <p>GREEN LIGHT ONLY</p> <p>COMPOSITE GROUP FLASHING (2+1) </p>	<p>PREFERRED CHANNEL TO PORT TOPMOST BAND RED</p> <p>RED LIGHT ONLY</p> <p>COMPOSITE GROUP FLASHING (2+1) </p>	<p>RED LIGHT ONLY</p> <p>FLASHING (2) </p> <p>FLASHING </p> <p>OCCULTING </p> <p>QUICK FLASHING </p> <p>ISO </p>
<p>1</p> <p>LIGHT <i>FI G 6s</i></p> <p>9</p> <p>LIGHTED BUOY <i>G "9" FI G 4s</i></p>	<p>A</p> <p>LIGHTED BUOY <i>GR "A" FI (2+1) G 6s</i></p>	<p>B</p> <p>LIGHTED BUOY <i>RG "B" FI (2+1) R 6s</i></p>	<p>2</p> <p>LIGHT <i>FI R 6s</i></p> <p>8</p> <p>LIGHTED BUOY <i>R "8" FI R 4s</i></p>
<p>9</p> <p>CAN <i>G C "9"</i></p> <p>5</p> <p>DAYBEACON <i>G "5"</i></p>	<p>U</p> <p>CAN <i>GR "U"</i></p> <p>S</p> <p>CAN <i>GR C "S"</i></p>	<p>C</p> <p>NUN <i>RG N "C"</i></p> <p>G</p> <p>NUN <i>RG "G"</i></p>	<p>6</p> <p>NUN <i>R N "6"</i></p> <p>2</p> <p>DAYBEACON <i>R "2"</i></p>

AIDS TO NAVIGATION HAVING NO LATERAL SIGNIFICANCE

<p>ISOLATED DANGER NO NUMBERS--MAY BE LETTERED</p> <p>WHITE LIGHT ONLY</p> <p><i>FI (2) 5s</i> </p> <p>A</p> <p>LIGHTED <i>BR "A" FI (2) 5s</i></p> <p>C</p> <p>UNLIGHTED <i>BR "C"</i></p>	<p>SAFE WATER NO NUMBERS--MAY BE LETTERED</p> <p>WHITE LIGHT ONLY MORSE CODE</p> <p><i>Mo (A)</i> </p> <p>A</p> <p>LIGHTED AND/OR SOUND <i>RW "N" Mo (A)</i></p> <p>B</p> <p>SPHERICAL <i>RW SP "B"</i></p> <p>N</p> <p>UNLIGHTED AND/OR SOUND <i>RW "N"</i></p>
<p>DAYBOARDS--MAY BE LETTERED</p> <p>WHITE LIGHT ONLY</p> <p>NR </p> <p>NG </p> <p>NB </p> <p><i>RW Bn</i> <i>GW Bn</i> <i>BW Bn</i></p>	<p>RANGE DAYBOARDS--MAY BE LETTERED</p> <p>KGW KWG KWB KBW KWR KRW KRB KBR KGB KBG KGR KRG</p>
<p>TYPICAL INFORMATION AND REGULATORY MARKS</p> <p>INFORMATION AND REGULATORY MARKERS WHEN LIGHTED, INFORMATION AND REGULATORY MARKS MAY DISPLAY ANY LIGHT RHYTHM EXCEPT QUICK FLASHING AND FLASHING (2)</p> <p>WHITE LIGHT ONLY</p> <p>DANGER <i>NW</i></p> <p><i>W Bn</i></p> <p>EXCLUSION AREA RESTRICTED OPERATIONS DANGER</p>	<p>SPECIAL MARKS--MAY BE LETTERED</p> <p>A <i>Y "A" C "A"</i></p> <p>C <i>Y "C" N "C"</i></p> <p>A <i>Y "A" Bn</i></p> <p>SHAPE OPTIONAL--BUT SELECTED TO BE APPROPRIATE FOR THE POSITION OF THE MARK IN RELATION TO THE NAVIGABLE WATERWAY AND THE DIRECTION OF BUOYAGE.</p> <p>B <i>Y "B" FI</i></p> <p>YELLOW LIGHT ONLY FIXED FLASHING</p>
<p>Aids to navigation marking the Intracoastal Waterway (ICW) display unique yellow symbols to distinguish them from aids marking other waters. Yellow triangles indicate aids should be passed by keeping them on the starboard (right) hand of the vessel. Yellow squares indicate aids should be passed by keeping them on the port (left) hand of the vessel. A yellow horizontal band provides no lateral information, but simply identifies aids as marking the ICW.</p>	

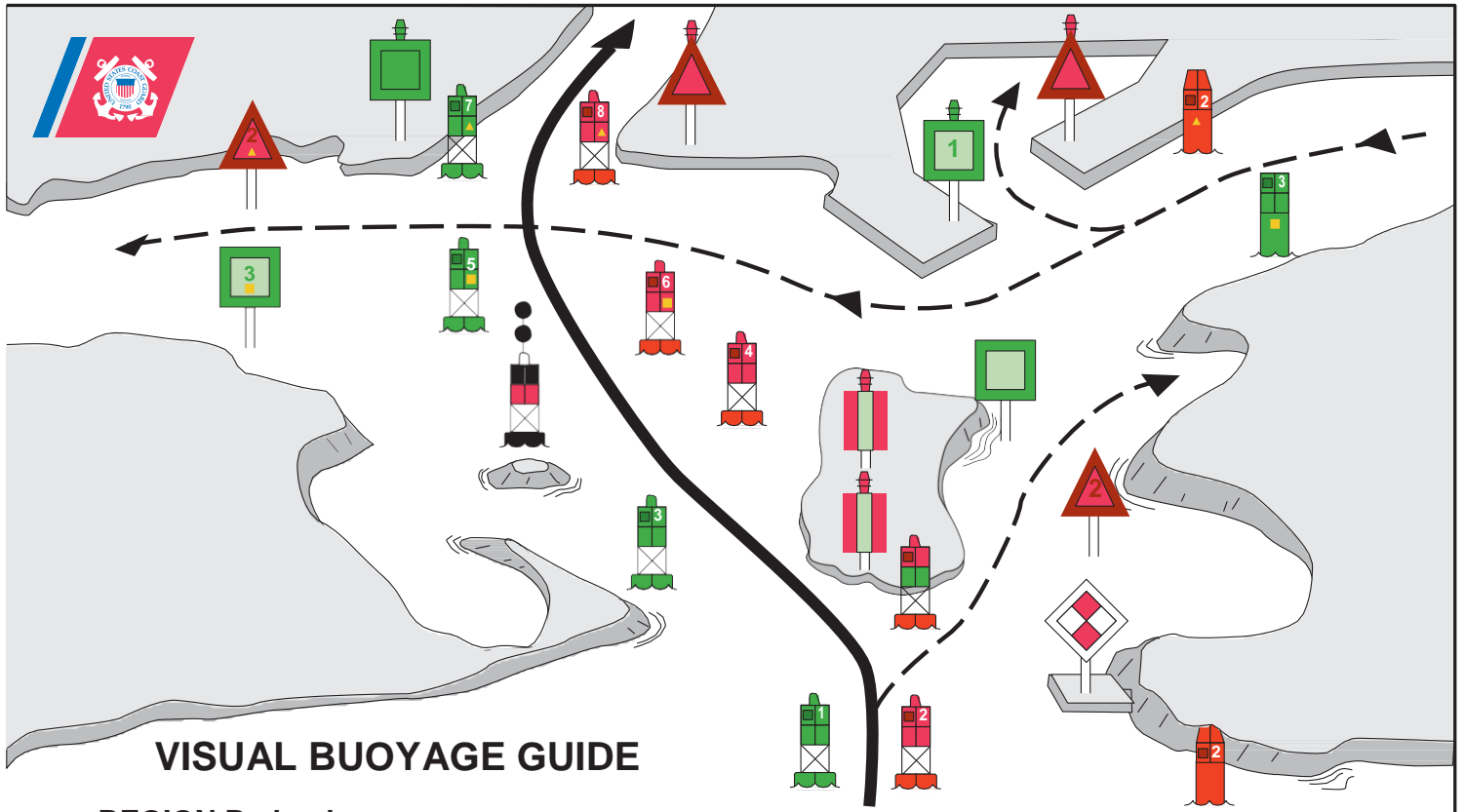

VISUAL BUOYAGE GUIDE

REGION B - by day

Preferred Channel 
 Secondary Channel 

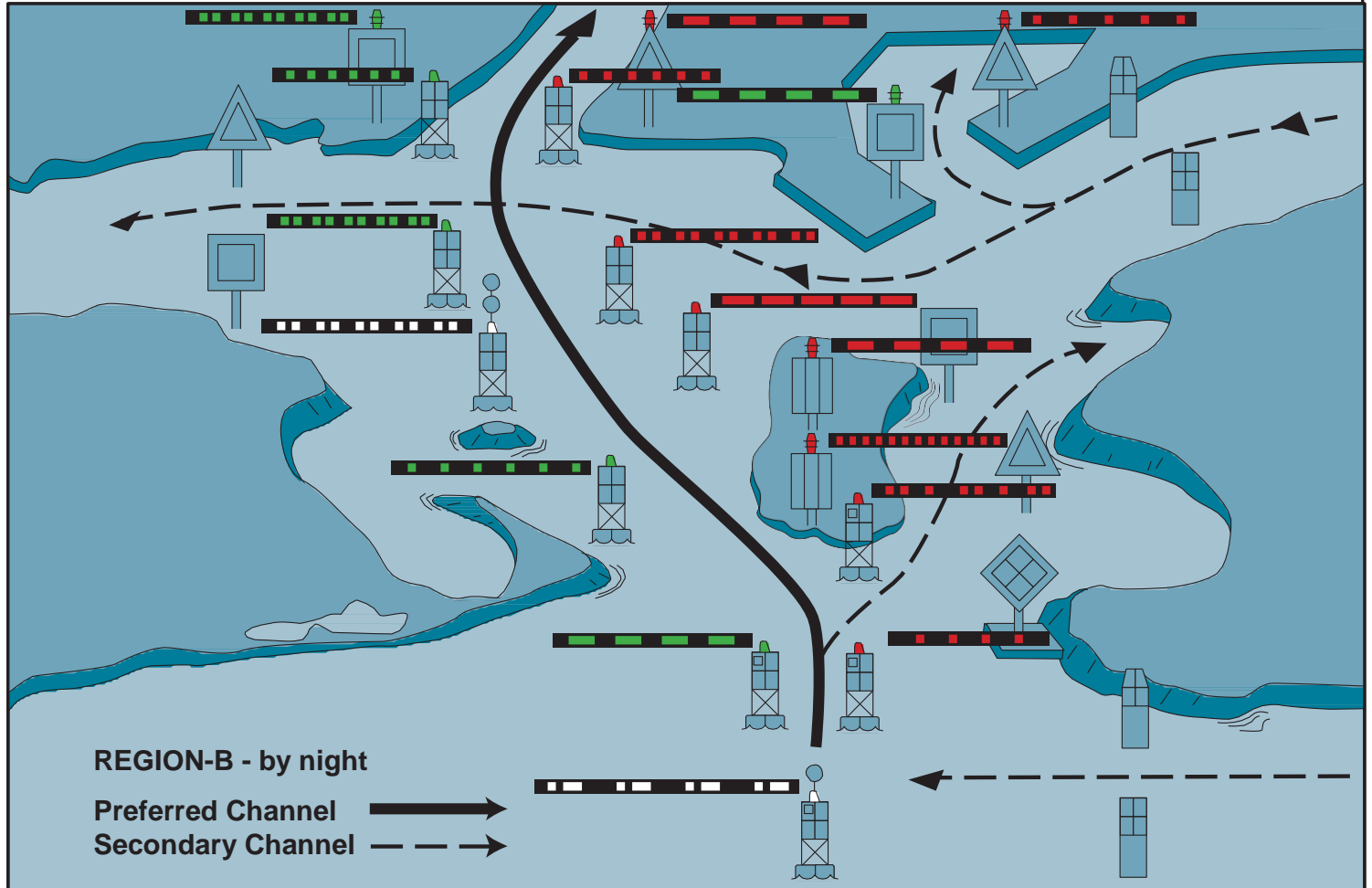

REGION-B - by night

Preferred Channel 
 Secondary Channel 



FICTITIOUS NAUTICAL CHART

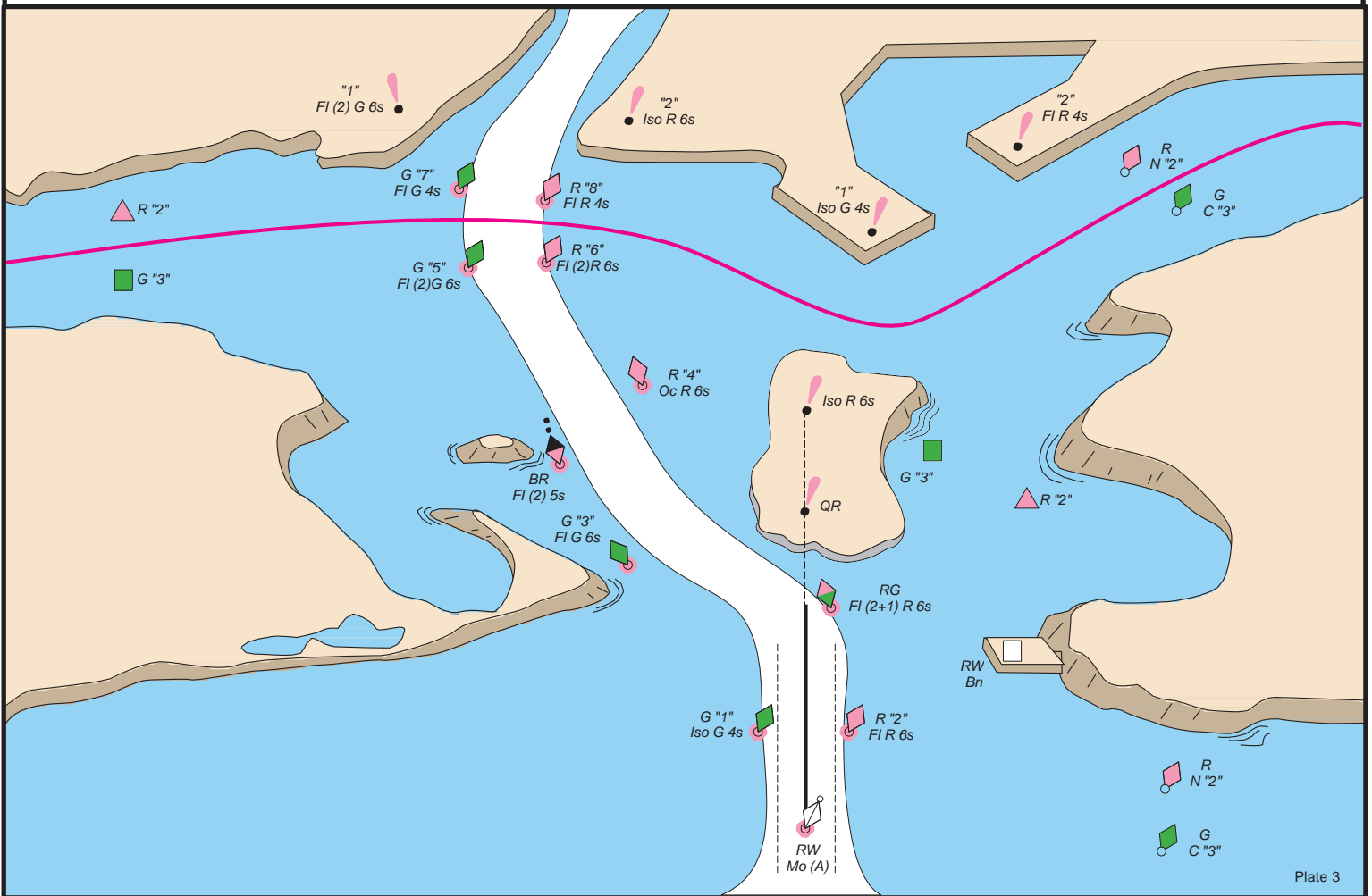

Tab 5- Required Safety Equipment

24-hour Motorboat Operator Training Manual

I. Introduction. Recreational vessels 65 feet and less in length are categorized into four classes. Each class of vessels has minimum equipment requirements established by Federal law. Each individual state and the Corps of Engineers (EM 385-1-1) also have specific equipment requirements for vessels under their jurisdiction.

II. Vessel Classes.

- A. Class A – Vessels less than 16 feet (4.9 m) in length.
- B. Class 1 – Vessels 16 feet to less than 26 feet (4.9 – 7.9 m) in length.
- C. Class 2 – Vessels 26 feet to less than 40 feet (7.9 – 12.2 m) in length.
- D. Class 3 – Vessels 40 feet to not more than 65 feet (12.2 – 19.8 m) in length.

For the purposes of this training our equipment requirements will only be based on **Class A and Class I** vessels

III. Required Equipment. The Coast Guard sets minimum safety standards for recreational boats and associated safety equipment. To meet these standards some of the equipment must be Coast Guard approved. "Coast Guard Approved Equipment" meets Coast Guard specifications and regulations relating to performance, construction or materials.

IV. Fire Extinguishers. Vessels are required to carry readily accessible fire extinguishers that are approved for marine use by the U.S. Coast Guard. The size and number of extinguishers acceptable for use on boats depend on the size of the boat and whether or not there is a fixed fire extinguishing system installed on the boat. All extinguishers must be readily accessible and they must be kept in a serviceable condition.

Fire Extinguishers

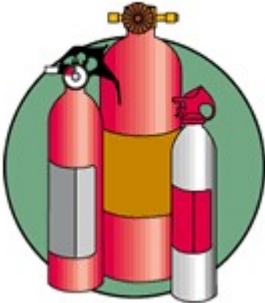

A. There are four types of fire extinguishing agents approved for use on vessels. All 4 of the extinguishing agents suppress a fire by smothering it.

1. Carbon Dioxide (CO₂). CO₂ extinguishers must be re-inspected every six months and be tagged. The containers must be hydrostatically tested every 5 years.

2. Dry Chemical. Dry chemical extinguishers are the most common extinguishers in use today.

3. Foam. Foam extinguishers that were manufactured prior to 1965 and were Coast Guard approved still meet the legal requirements as long as they are in serviceable condition. Foam extinguishers manufactured after 1965 are not approved for marine use.

4. Halon-1301 can still be used if it's an existing system. You can even get it recharged with reclaimed agent. Halon is no longer manufactured, but it's still out there. Alternatives to Halon-1301, you have FM-200 (or FE-227), FE-13, FE-25, Novec-1230, and inert gas systems like Argonite or Inergen. In portable fire extinguishers, Halon can still be recharged, although it's Halon-1211 in portables. Other agents that work good in a hand-portable are Halotron and FE-36.

B. Classification of Fire Extinguishers. Fire extinguishers are classified by a letter and number symbol. The number indicates the relative size of the extinguisher while the letter indicates the type of fire it can effectively extinguish.

A - Combustible solids (wood, paper).

B - Flammable liquids (gasoline, solvents, grease, oil, some paints).

C - Electrical equipment (wiring, fuse boxes, energized electrical equipment).

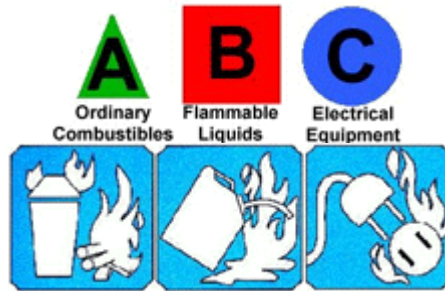

	Foam (gals)	CO2 (lbs)	Dry Chemical (lbs)	Halon (lbs)
B-I	1.25	4	2	2.5
B-II	2.5	15	10	10

B. Fixed extinguisher systems.

1. Coast Guard approved systems are required to have a discharge indicator. This is usually a pressure gauge visible outside the engine compartment or an indicator light located in the Helmsman's position, which will show the operator if the system has been discharged.

2. Systems shall be either Halon or dry chemical. Halon-1301 can still be used if it's an existing system. You can even get it recharged with reclaimed agent. Halon is no longer manufactured, but it's still out there.

C. Fire extinguisher requirements on recreational vessels.

1. The number of approved fire extinguishers required to be aboard a recreational vessel depends upon the length and/or construction of the vessel.

2. Fire extinguishers are required on all recreational boats, which have compartments, wherein explosive or flammable gases or vapors can be trapped. The following conditions require a fire extinguisher.

- a. Closed compartments under thwarts and seats wherein portable fuel tanks may be stored.
- b. Unsealed double-bottoms not completely filled with flotation material.
- c. Closed living spaces.
- d. Closed stowage compartment in which combustible or flammable materials are stowed.
- e. Permanently installed fuel tanks. A tank is permanent if it is secured in any way. If weight or location is such as to likely prevent someone from removing it in an emergency, the tank is considered permanent.

location is such as to likely prevent someone from removing it in an emergency, the tank is considered permanent.

3. The following conditions do not, in themselves, require that fire extinguishers be carried.

- a. Bait wells or ice chests/coolers.
- b. Glove compartments.
- c. Buoyant flotation materials.
- d. Open slatted flooring.

4. All recreational boats meeting the necessary requirements must carry at least the minimum number of hand portable fire extinguishers required for its size.

5. Some vessels are known as “open boats”. These vessels are constructed so no flammable gases or vapors can be trapped in any area of the boat, are propelled by outboard motors with portable fuel tanks, and are not carrying passengers for hire. These vessels are not required to carry fire extinguishers.

6. The following chart lists the number of extinguishers that are required. In the case where a Coast Guard approved pre-engineered fire extinguishing system is installed for the protection of the engine compartment, the required number of units may be reduced in accordance with the chart.

Minimum Number of Hand Portable Fire Extinguishers Required		
Vessel Length	No Fixed System	With Approved Fixed Systems
Less than 26'	1 B-I	None

D. In order for a fire extinguisher to be acceptable for use it must meet the following:

1. It must be readily accessible and mounted in its specific marine-type bracket.
2. It must be in good condition and serviceable.
3. An approved extinguisher is marked by the following method:

Marine Type U.S.C.G.
Type _____ Size _____
USCG Approval Number 162.028

E. Boat operators should check their fire extinguishers for:

1. USCG approval.
2. Proper mounting bracket and in condition for immediate use.
3. Proper size and type for vessel.
4. Check nozzles of extinguisher regularly to ensure that they are clear of obstructions.
5. Check gauges regularly to make sure that the extinguisher is charged and that the plastic gauge cover is not damaged.
6. Dry chemical extinguishers without gauges or indicating devices must be inspected every 6 months. If the gross weight of a CO2 extinguisher is reduced by more than 10% of the net weight, the extinguisher is not acceptable and must be recharged.
7. Dry chemical extinguishers should be turned upside down to check for clumping of chemicals. If chemicals are clumped together, the extinguisher is not acceptable.

V. Personal Flotation Devices (PFD's). PFD's are designed to help you remain afloat in the water and to keep your head and face in a position which permits breathing. More than 90% of deaths in boating are from drowning and at least 80% of those drowning victims were not wearing a PFD. PFD's aid you against drowning and also help protect you from hypothermia, which is another major cause of death in boating accidents.

There are two types of flotation devices. Each is designed for different boating activities and water conditions and has its own maximum buoyancy, performance level, and limitations. You should choose your life jacket based on your boating activities and conditions. PFD's must be in serviceable condition, must be the appropriate size and fit for the intended wearer as marked on the Approval Label and they must have an Approval Number as specified in 46 CFR, Part 160.

Wearable PFD:

Adult: (persons weighing more than 90 pounds and providing **25 pounds of buoyancy** in fresh water for 48 hours.

Child: (persons weighing less than 90 pounds and providing **16.5 pounds of buoyancy** in fresh water for 48 hours.

ALL Wearable PFD's:

- shall support the wearer in the water in an upright or slightly backward position, and shall provide support to the head so that the face of an unconscious or exhausted person is held above the water
- shall be capable of turning the wearer, upon entering the water, to a safe flotation position as described above

Throwable PFD: These are designed to be thrown to a person in the water. Throwable devices include boat cushions, ring buoys, and horseshoe buoys. They are not designed to be worn and must be supplemented by a wearable PFD. It is required to keep these devices immediately available for emergencies. These throwable PFD's are constructed of cork or foam with either a canvas or special purpose plastic covering. Rings may be equipped with grab lines. Cushions are made of fibrous glass or foam with vinyl dipped material covering and straps for grasping. All cushions carry a warning against wearing on the back. The **minimum buoyancy is 16.5 pounds for ring buoys or 18 pounds for boat cushions.**

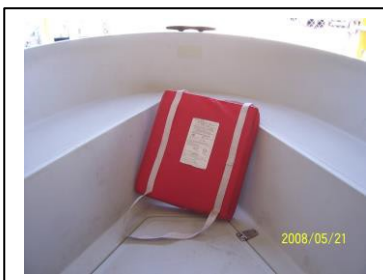

A. Federal PFD requirements.

1. **Class A boats.** On boats less than 16 feet in length there must be one Wearable PFD for each person on board. They must be readily accessible and of a suitable size and fit for the intended wearer.

2. **Class I boats.** On boats 16 feet in length and over there must be one Wearable PFD for each person on board plus at least one Throwable PFD that must be immediately available.

3. On any boat underway a child under the age of 13 must wear an appropriate USCG approved PFD unless they are below decks or in an enclosed cabin. Individual State statutes for age requirements preempt this USCG requirement so be sure and check your area of operation for the proper age requirement.

B. Maintenance of PFD's should be done in accordance with the Manufacturers recommendation and owner's manual. At a minimum

1. Check your life jackets before each use.
2. Check that all hardware and straps are in working order.
3. Check for rips, tears, leaks, mildew, lumpy or hardened buoyancy material, and oil saturation in the fabric .
4. Don't use PFD as a kneeling pad or boat fender.
5. If wet, allow it to dry thoroughly in open air before storing.

VI. Visual Distress Signals (VDS). All vessels used on coastal waters, the Great Lakes, territorial seas, and those waters connected directly to them, up to a point where a body of water is less than two miles wide, must be equipped with U.S.C.G. Approved visual distress signals. Vessels owned in the United States operating on the high seas must be equipped with U.S.C.G. Approved visual distress signals.

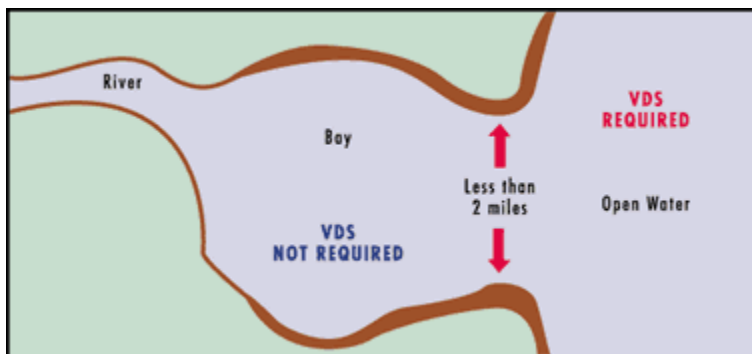

A. The following vessels are not required to carry day signals but must carry night signals when operating from sunset to sunrise:

1. Recreational boats less than 16 feet in length.
2. Boats participating in organized events such as races, regattas, or marine parades.
3. Open sailboats less than 26 feet in length not equipped with propulsion machinery.
4. Manually propelled boats.

B. Pyrotechnic Visual Distress Signals. Pyrotechnic Visual Distress Signals must be Coast Guard Approved, in serviceable condition, and readily accessible. They are marked with an expiration date. Expired signals may be carried as extra equipment, but cannot be counted toward meeting the visual distress signal requirement, since they may be unreliable. Launchers manufactured before January 1, 1981, intended for use with approved signals, are not required to be Coast Guard Approved. If pyrotechnic devices are selected a minimum of three are required. That is, three signals that meet both day and night use requirements. Pyrotechnic devices should be stored in a cool, dry location, if possible. A watertight container painted red or orange and prominently marked "DISTRESS SIGNALS" or "FLARES" is recommended.

1. Flare Pistol. The flare pistol is approved for day and night use. The flare has a 6-7 second burn time, reaches an altitude of 250-500 feet and produces 10-15,000-candle power of light. You should only use these flares if you are in sight of a ship or plane or if you are reasonably sure that someone on shore may see you. In some states the pistol launcher for meteors and parachute flares may be considered a firearm. Therefore, check with your state authorities before acquiring such a launcher.



2. Hand-held Flares. Hand-held flares are approved for day or night use. These flares have a 3 minute burn time that produces 700 candle power. You should only use these flares if you are in sight of a ship or plane or if you are reasonably sure that someone on shore may see you.



3. Orange Smoke Flare. Orange smoke flares are approved for daytime use only. This flare produces a cloud of orange smoke with a 60 second burn time with a maximum visibility of 5 miles. The flare is either hand-held or it floats in the water. You should only use these flares if you are in sight of a ship or plane or if you are reasonably sure that someone on shore may see you.

C. Non-Pyrotechnic Visual Distress Signals. Non-Pyrotechnic Visual Distress Signals must be in serviceable condition, readily accessible, and certified by the manufacturer as complying with U.S.C.G. requirements.

1. Orange Distress Flag. The orange distress flag is used during the daytime only. The flag is orange and displays a black ball over a black square and must be at least 3' x 3' in size. The flag is most distinctive when attached to and waved on a paddle, boathook, or flown from a mast. It may also be incorporated as part of devices designed to attract attention in an emergency, such as balloons, kites, or floating streamers.

2. Electronic Distress Light. The electronic distress light is for nighttime use only. This light automatically flashes the international SOS distress signal. This light must be marked with an indication that it meets Coast Guard requirements in 46 CFR 161.013.



3. Under Inland Navigation Rules, a high intensity white light flashing at regular intervals from 50-70 times per minute is considered a distress signal. Such devices do NOT count toward meeting the visual distress signal requirement.

C. Federal Requirements.

1. If using pyrotechnic devices, at least 3 day and 3 night devices must be carried or 3 combination day/night devices.
2. If using non-pyrotechnic devices, at least 1 day and 1 night device must be carried.
3. Vessels may also carry any combination of pyrotechnic and non-pyrotechnic devices so long as the minimum number required per type is carried.
4. Class A vessels must carry VDS when operating at night on required waters.
5. Class I, II, and III vessels require VDS at all times when operating on required waters.
6. Open sailboats less than 26 feet in length not equipped with propulsion machinery and manually propelled boats are not required to carry VDS.
7. All vessels used on coastal waters, the Great Lakes, territorial seas, and those waters connected directly to them, up to a point where a body of water is less than two miles wide, must be equipped with U.S.C.G. Approved visual distress signals.

VII. Sound Producing Device. The navigation rules require sound signals to be made under certain circumstances. Meeting, crossing and overtaking situations described in the Navigation Rules are examples of when sound signals are required. Recreational vessels are also required to sound signals during periods of reduced visibility.

Signaling Devices



- A. Class A and Class I Vessels must have some means of making an efficient sound signal. An efficient sound signal is defined as a device that can produce a four to six second blast.

VIII. Navigation Lights. Recreational vessels are required to display navigation lights between sunset and sunrise and other periods of reduced visibility (fog, rain, hazy, etc.). The U.S. Coast Guard Navigation Rules, International-Inland, specifies lighting requirements for every description of watercraft. The information provided here is intended for power-driven vessels less than 26 feet in length.

On a vessel, navigation lights are lights shown that are of a specific color, (white, red, green, yellow, blue), arc, range of visibility, and location, as required by law and regulations. Their basic purpose is to prevent collisions by alerting each vessel to the other's presence. Lights also indicate the relative heading of one vessel as seen from another, and give clues to her size, special characteristics, and/or current operations, and who has the right of way.

A. Light Definitions.

1. Anchor light - an all-around white light exhibited where it can best be seen and is visible for two miles.
2. Masthead light - A white light placed over the fore-and-aft centerline of the vessel, showing an unbroken light over an arc of 225 degrees, from dead ahead to 22.5 degrees abaft (behind) the beam on both sides of the vessel. On boats less than 12 meters (39.4 feet) in length, the masthead light may be off the fore-

and-aft centerline, but must be as close to it as possible. The term "masthead light" is something of a misnomer. More often than not, this light is not at the top of the mast. On motorboats, it is often on a short staff at the top of the cabin. On sailboats, it is usually part way up the mast, and another light, the anchor light, is actually at the masthead.

3. Sidelights - Colored lights - red on port and green on starboard - showing an unbroken arc of the horizon of 112.5 degrees, from dead ahead to 22.5 degrees abaft the beam on each side.

4. Combination lights - On a vessel of less than 20 meters (65.6 feet) in length, the sidelights may be combined in a single fixture carried at the centerline of the vessel, except that on boats less than 12 meters (39.4 feet) in length, this combination light need be carried only as close to the centerline as possible.

5. Stern light - A white light showing over an unbroken arc of the horizon of 135 degrees, centered on dead astern.

6. All-Around Lights - A light, the color determined by its use, showing over an unbroken arc of the horizon of 360 degrees.

B. Power-Driven Vessels.

1. A recreational powerboat under way is required to display a masthead light forward, red and green sidelights and a stern light, as indicated in Figure 1.

Figure 1

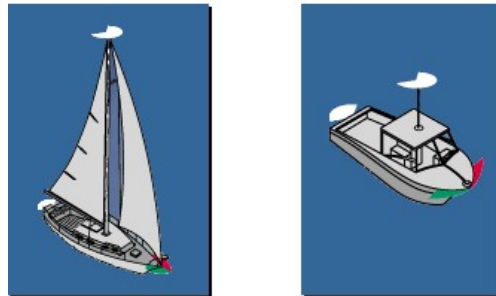

2. A recreational powerboat may instead display a 360' all-round white light (Figure 2)

Figure 2

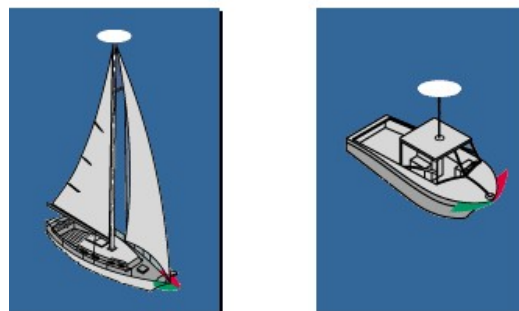

C. Anchored Vessels.

1. Power-driven vessels and sailing vessels at anchor must display an all-around white anchor light (Figure 8).

2. Vessels less than 23 feet (7 meters) in length are not required to display anchor lights unless anchored in or near a narrow channel, fairway or anchorage, or where other vessels normally navigate.

Figure 8

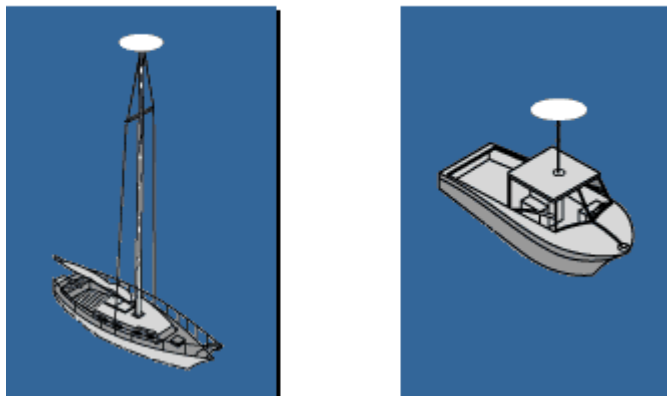

IX. Corps of Engineer Requirement's. Government operators shall be licensed and certified in accordance with ER 385-1-91 and EM 385-1-1

EM 385-1-1 references:

- 01.A.15.a. An AHA shall be prepared and documented for each USACE activity as warranted by the hazards associated with the activity
- 03.B.01 b. TYPE III, 16 unit first aid kit (EM 385-1-1, Table 3-1)
- 05.J.01 Inherently buoyant Type III, Type V work vests, or better USCG-approved personal flotation devices (PFDs) shall be provided and properly worn (zipped, tied, latched, etc., in closed fashion) by all persons in the following circumstances:
 - ▶ a. On floating pipelines, pontoons, rafts, or stages
 - ▶ b. On structures or equipment extending over or next to water except where guardrails, personal fall protection system, or safety nets are provided for employees
 - ▶ c. Working alone at night where there are drowning hazards, regardless of other safeguards provided
 - ▶ d. In skiffs, small boats, or launches, unless in an enclosed cabin or cockpit; or
 - ▶ e. Whenever there is a drowning hazard
- 05.J.02 Automatic-Inflatable PFD's Type V or better, USCG approved for commercial use, may be worn by workers in lieu of inherently buoyant PFD's provided the following criteria are met:
 - ▶ Over 16 years old and weigh 90 lbs. or more
 - ▶ Activity Hazard Analysis (AHA) shall be developed for the intended activity
 - ▶ PFDs must be inspected, maintained, stowed and used in accordance with the manufacturer's instructions. PFD's used in heavy construction or maintenance activities or where hot work (welding, brazing, cutting, soldering, etc.) is to be performed must be designed, tested and certified by the manufacturer for this type of work; **NOTE: The standard commercial auto-inflatable PFD does not meet these requirements**

- ▶ PFDs shall provide a 30-pound minimum buoyancy post-deployment and have a status indicator window
- ▶ Personnel shall be trained in the use, maintenance, restrictions, care, storage inspection and post-deployment procedures per manufacturer's instructions
- ▶ The USCG-approval for auto-inflatable PFD's is contingent upon the PFD being worn not stowed. All auto-inflatable PFDs must be worn at all times drowning hazard exists
- ▶ In-water testing is required for all first time users to so that wearers become familiar with the feel and performance of the PFD
- ▶ Must be worn



- 05.J.03 All wearable PFD's shall be of an international orange (or orange/red) or ANSI 107 yellow green color.
 - ▶ Each inherently buoyant PFD shall have at 31 sq. in. (200 sq. cm.) of retro-reflective material attached to its front side and at least at 31 sq. in. (200 sq. cm.) on its back side per USCG requirements (46 CFR Part 25.25-15)
 - ▶ Each auto-inflatable PFD shall have at 31 sq. in. (200 sq. cm.) of retro-reflective material attached to its front side and at least at 31 sq. in. (200 sq. cm.) on its bladder, to be visible when deployed

- 05.J.06 d. Ring Buoys (20" diameter) shall have at least **90** ft of 3/8 in. solid braid polypropylene, or equivalent, attached. Throw bags may be used *in addition to* ring buoys. These throwable devices and lifelines shall be inspected at a minimum of every six months and stored in such a manner to allow immediate deployment and be protected from degradation from weather and sunlight



- 19.A.05 a. Fenders shall be provided to prevent damage and sparking and to provide safe areas for workers exposed to pinching situations.



- 19.A.05 c. Signal Devices (lights, sound devices, etc.) shall be provided on all vessels to give signals required by the navigation rules applicable to the waters on which the vessel is operated on.
- 19.B.04 a.
 - (1) At least one portable or permanent ladder of sufficient length to allow a person to self-rescue by boarding the ladder from the water
 - (2) Other methods or means designed to assist in the rescue of an incapacitated person overboard



- 19.D.07 Small boats with length 26 ft (7.9 m) or less shall be provided with integrated combinations of two or more of the below listed items to provide continuous perimeter protection around the vessel. The installations shall be in accordance with either ABYC Standards or ISO Standard 15085, as demonstrated by a Manufacturer's certificate, label or other documentation.
 - ▶ Cockpits
 - ▶ Coamings
 - ▶ Handholds
 - ▶ Toe Rails
 - ▶ Life Rails
 - ▶ Deck Rails
 - ▶ Stern Rails
 - ▶ Bow Rails



- 19.F.02 d. All open cabin launches or motorboats shall be equipped with "kill (dead man) switches".
- 19.F.03 a. The minimum number and rating of fire extinguishers that shall be carried on motorboats:
 - Class A and Class I = One, 1-A:10B-C
 - Class II and III = Two, 1-A:10B-C
- 19.F.03 b. All motorboats having gasoline or liquid petroleum gas in cabins, compartments or confined spaces shall be equipped with an automatic CO2 fire extinguishing system.



- 19.F.04 Float Plans containing the following information shall be prepared by the motorboat operator when engaged in surveying, patrolling or inspection activities that are remote and expected to take longer than four hours or when travelling alone and filed with the operators supervisor.
 - ▶ Vessel information
 - ▶ Personnel on board
 - ▶ Activity to be performed
 - ▶ Expected departure, route and time of return
 - ▶ Means of communication

- 19.F.05 All motorboat operators shall complete and document the following training
 - ▶ A boating safety course meeting the criteria of the USCG Auxiliary, National Association of State Boating Law Administrators (NASBLA), or equivalent; and
 - ▶ Motorboat handling training, based on the types of boats they will operate, provided by qualified instructors (in-house or other). Operators must pass a written and operational test
 - ▶ c. Current USCG licensed personnel are exempt from the boating safety training, but they shall complete the written exam and operational test
 - ▶ d. Government employees shall complete a USACE-approved 24-hour initial boating safety course and refresher as prescribed in ER 385-1-91

Additional recommended safety equipment:

- ▶ Anchor and line
- ▶ Tow line and bridle
- ▶ Radios/electronics
- ▶ Mooring lines
- ▶ Boat hook
- ▶ Bilge pump(s)
- ▶ Rescue line
- ▶ Paddle
- ▶ Compass
- ▶ Tool kit
- ▶ First aid kit
- ▶ Navigation kit
- ▶ GPS
- ▶ Nautical Chart
- ▶ Hand-held light
- ▶ Additional PFD's

Personnel Protective Equipment (29 CFR 1910.132)

- ▶ EYE PROTECTION - Clear/tinted, impact rated
- ▶ FOOTWEAR - Non-skid/scuffing, cushioning, insulation
- ▶ HEARING PROTECTION - Ear muffs/plugs
- ▶ U.V. RAY PROTECTION - Sun block, clothing

U.S. Army Corps of Engineers

Boat Operations Float Plan

DATE:

LAUNCH SITE:

DEPARTURE TIME:

EXPECTED RETURN TIME:

ROUTE OF TRAVEL:

VESSEL:

VEHICLE:

PERSONNEL ON BOARD:

CONTACT INFORMATION:

MISSION:

Tab 6 - Fire Suppression

24-hour Motorboat Operator Training Manual

I. Basics of fire suppression.

A. The first priority of fire suppression is to save lives, not property (boats). This fire fighting training is provided to contain a small fire to enable a safe exit of occupants.

B. The fire triangle is made up of three elements: heat, oxygen, and fuel. If you remove any one of these elements the fire will be extinguished.

C. Review "Equipment Requirements" tab to review fire extinguisher types.

D. This is "1st Aid" fire fighting. The equipment and techniques are designed to knock down a very small fire or at least slow it down until occupants exit and professional help arrives.

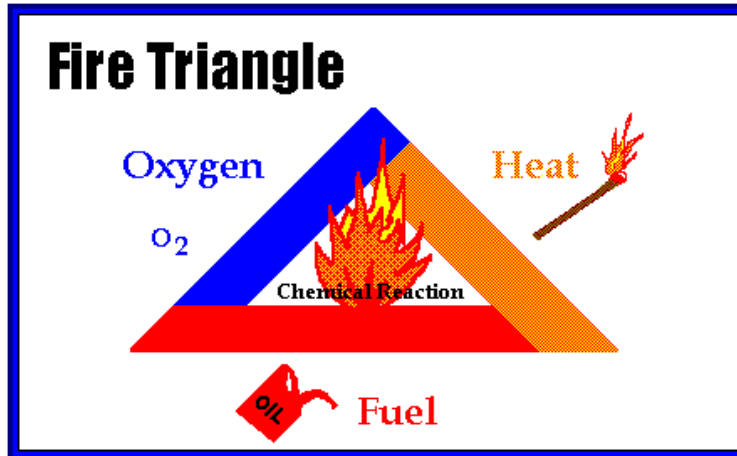

II. P.A.S.S.



A. **PULL the pin:** This unlocks the operating lever and allows you to discharge the extinguisher. Some extinguishers may have other lever-release mechanisms.



and allows you to other lever-release

B. **AIM low:** Point the extinguisher nozzle (or hose) at the base of the fire.



C. **SQUEEZE the lever above the handle:** This discharges the extinguishing agent. Releasing the lever will stop the discharge. (Some extinguishers have a button instead of a lever.)

D. **SWEEP from side to side:** Moving carefully toward the fire, keep the extinguisher aimed at the base of the fire and sweep the flames appear to be out. Watch the fire area. If the fire process.



toward the fire, keep back and forth until re-ignites, repeat the

III. What to do if your boat catches fire.

- A. Come to a full stop as soon as possible. Continuing to move will fan the flames
- B. Make sure all passengers have on a PFD
- C. Position boat so that smoke and flames are downwind
- D. If burning material is not attached and is accessible, throw it over the side.
- E. Use P.A.S.S. method to attempt to extinguish fire
- F. Summon help via VHF marine radio
- G. Abandon ship if necessary.

Tab 7 - Emergency Procedures

24-hour Motorboat Operator Training Manual

I. Introduction.

A. Background.

1. Most boating fatalities involve capsizing or falls overboard, i.e., people end up in the water that were not planning on being there and were not wearing a PFD.

2. Vessels less than 16 feet account for most fatalities. Ironically, small vessels have less stringent equipment requirements.

3. Most drownings occur within ten feet of safety. Therefore, chances are that most rescues will be a simple reach or throw.

B. Priorities in rescue situations.

1. Self is most important. Do not do anything that will endanger you during a rescue attempt.

2. Your partner(s) are second in importance. Ensure that both you and your rescue partner(s) are safe during any rescue attempt.

3. The victim is least important. You and your rescue partner(s) should not do anything that will cause them to become a victim during a rescue attempt.

C. Characteristics of a person in distress.

1. Can wave and yell for help.

2. Has not yet reached the panic stage.

D. Characteristics of a person drowning.

1. Cannot speak, consciously wave for help, or consciously grab rescue device.

2. Has reached the stage of total panic.

3. May have as little as 20 to 60 seconds before they go under; or may disappear immediately.

4. Appear to be doing a sideways breaststroke with arms raised above the head and moving down onto the water. The head is tilted way back and the mouth is wide open. May have the appearance of playing or splashing.

5. Will drown you if they can get close enough to you.

II. Rescue Sequence. Always consider rescue techniques in this order. **Talk, Reach, Throw, Row, Go.**

A. **Talk.** Try to talk the victim into self-rescue if the situation permits. Remember to maintain visual and verbal contact with the victim while using any rescue technique.

B. **Reach.** Reach towards the victim with something that the victim can grab hold of and be pulled to safety.

1. Use pike pole, paddle, fishing pole, etc. to reach out to victim.

2. Place reach device in the victim's hand or under their arm. A drowning victim cannot think rationally to reach out and grab hold of the item. If the device touches them, the victim will grab hold of it instinctively.

3. Be careful that the victim doesn't pull in the rescuer. The rescuer should be prepared to let go of reach device if they are in danger of being pulled into the water with the victim.

4. Rescuer can extend an arm or leg to the victim, but be sure that the rescuer is firmly anchored to safety. This is a dangerous maneuver because the rescuer may not be able to let go if the victim is pulling the rescuer into the water.

C. **Throw.** Throw an object that floats to the victim and that is attached to a line to pull the victim to safety.

1. Use the throwing technique when conditions or time prevent a reach rescue.

2. Throw upstream or upwind so device will float to victim.

3. Shout "rope" when throwing.

4. Type IV ring buoy with 90 feet of polypropylene line attached.

a. Required by EM 385-1-1 on all Corps vessels.

b. A ring buoy is the best choice for a victim in the panic stage or unable to keep themselves afloat.

c. Rescuers must practice throwing ring buoy to maintain proficiency. Inexperienced rescuer may have trouble with throwing distance and accuracy.

5. Throw bag or heaving line.

a. These aids offer no flotation to the victim.

b. Inexperienced rescuers may find the throw bag or heaving line easier to use than a ring buoy.

c. These aids are good for use with victims able to float unassisted and not in the panic stage.

d. Throw bags or heaving lines must be thrown past the victim so they may grab the line and not the bag.

6. Other possible throwing items may include any type PFD, cooler, spare tire, or anything that floats.

D. **Row.** Use a boat to go to the victim.

1. Approach victim into the wind or current for more positive control of your vessel.

2. Use reach and throw techniques when the vessel is close enough to the victim.

3. As your boat nears the victim, shut the engine off unless other hazards dictate otherwise (nearby dam, currents, high winds, etc.).

E. **Go.** Go to the victim using in-water rescue techniques as a last resort.

1. Special notes.

a. In-water rescue is the most dangerous form of rescue that should only be attempted by individuals who have been trained, who consistently practice, and who are in adequate physical condition.

b. Cold water rescue (water temperature less than 70 degrees) requires the use of a cold-water survival suit.

c. Use in-water rescue as a last resort when all other methods have failed or are impossible.

2. Unconscious victim rescue.

a. The rescuer, wearing a PFD, enters the water feet first and swims to victim with a ring buoy and line.

b. Rescuer slips ring buoy down one of victim's arm and shoulder.

c. Rescuer places own arm through the crook in victim's other arm and grabs ring buoy.

d. Victim's head will now be supported above the water and victim can be towed to safety. Victim can be given artificial respirations in this position if needed.

3. Conscious victim rescue. This is the most dangerous rescue technique!!

a. The rescuer, wearing a PFD, enters the water feet first and swims to victim with a type IV or other type of PFD. A line may be attached to the rescuer or the PFD.

b. Rescuer shoves the PFD towards the victim while keeping away from the victim. Rescuer continues to maintain visual and verbal contact with the victim.

c. Rescuer tows victim back to safety, while keeping away from the victim at all times.

d. If the victim grabs hold of the rescuer, the rescuer should swim underwater forcing the victim to let go to come up for air.

III. Getting victims into the rescue boat.

A. Know your boat. Use the stern or as far astern as possible. Some boats will not safely allow an over-the-side retrieval.

B. Conscious victim with no major injury.

1. A ladder is the easiest and most effective means of boarding a boat. EM 385-1-1 requires Corps vessels to carry a boarding ladder.

2. A stirrup can be made by tying loops in a line and fastening it to a cleat. Victim can then climb the loops as a rope ladder.

3. Retrieval strap.

a. Put a loop of rope or webbing under the victim's armpits.

b. May need two rescuers to lift the weight of the victim.

c. May need to use the bounce technique. Bounce twice, pulling victim as high as possible on the second bounce into the boat.

C. Unconscious or weak victims can be rolled aboard the vessel.

1. Secure the end of a rescue net or blanket by tying it to the side of the boat or by standing on it.

2. Put the rest of the net/blanket in the water and cradle the victim with it.

3. Rescuers pull up in unison, rolling the victim up and over the side of the boat while at the same time turning the excess net/blanket outward to prevent entanglement.

4. Do not use this technique if the victim has suspected cervical injuries or other trauma.

D. Suspected spinal injuries.

1. Rescuing victims with suspected spinal injuries requires highly specialized training and equipment. In some cases, this rescue will be provided by local emergency medical services (EMS).

2. Symptoms of spinal injuries may include severe neck or back pain, loss of movement and feeling in extremities, tingling, deformity of back or neck, and breathing stopped.

3. If hypothermia or other life threatening conditions are not a factor, keep the victim in the water until EMS or trained personnel arrive. Try to eliminate any movement caused by waves and wakes.

4. One method of spinal injury management is provided for informational purposes. This technique requires special training and practice.

a. While still in the water, keep head and neck aligned and not moving by using the vice grip technique.

b. Place one forearm on the victim's sternum and the other on the victim's spine.

c. Support the victim's head by cupping the chin and back of the skull with your hands.

d. Put pressure on the victim's chest and spine, not on the head.

5. Move the victim only if a life threatening, immediate danger exists (i.e. dam, fire, hypothermia). Try to minimize head and neck movement as much as possible. This is a desperate, last-ditch effort used only when not moving the victim would result in certain death. Secure the victim to a backboard or makeshift backboard if possible.

IV. Getting yourself back into your boat unassisted.

A. **Chin-up bounce:**

1. This technique is difficult for most people or for use on high-sided boats.

2. Grab the stern or gunwale at the lowest point and bounce up as if doing a chin up.

3. Try to get the upper half of your body over the gunwale and into the boat.

B. **Stirrup:** This technique can be used by finding a loose line hanging off the boat and tying it into a loop. Put your foot into the loop, grab the stern or gunwale, stand up and pull yourself into the boat.

C. **Cavitation plate.**

1. Ensure that the engine is off. Be careful of slippery surface of cavitation plate. Be careful of hot surfaces on the engine. Stay away from the prop as much as possible.
2. Find the cavitation plate above the propeller and use it for a step.
3. Place your foot closest to engine on the plate.
4. Find hand holds on the motor or cleats.
5. Stand up and pull yourself up as if climbing a ladder.

D. **Ladder:** This technique is the easiest and most effective means of boarding a boat. EM 385-1-1 requires Corps vessels to carry a boarding ladder.

V. Self-rescue in cold water.

A. Hypothermia basics (lowering of body temperature).

1. Water conducts heat 25 to 35 times as fast as air.
2. Try and get as much of your body out of the water as possible, no matter how cold or windy it is (i.e. crawl up on top of your overturned boat).
3. Keep all clothing on and buttoned up. Many studies show this will keep you warmer and more buoyant.
4. Anticipate harsh conditions. Wear wool instead of cotton, wear a hat, wear a float coat type PFD, etc.
5. In most cases it is better to stay put rather than swimming or treading water, which causes rapid loss of body heat.
6. During a sudden immersion, cover your mouth and nose to prevent gasping in water.

7. Water Temperature (degree F)	Survival Time
32.5	15-45 minutes
32.5 – 40	30-90 minutes
40 – 50	1-3 hours
50 – 60	1-6 hours

8. Water less than 70 degrees F is considered cold water.

B. Heat Escape Lessening Posture (HELP).

1. Cross legs, fold arms, bring knees up, hunch shoulders to neck.
2. HELP prevents heat loss from head, neck, underarms, and groin.
3. HELP works only while wearing a PFD, although HELP position is difficult with some types of PFDs. Even a partial HELP position is beneficial.

4. HELP can increase survival time as much as 4 times.

C. HUDDLE.

1. Use this position when there are 2 or more victims.
2. Victims wrap arms around each other and lock their legs together.
3. HUDDLE position can increase survival time as much as 4 times.

D. Cold water near drowning.

1. Prolonged submersion in cold water may not necessarily result in drowning.
2. There have been numerous documented cases of recovery after 1 hour of submersion. The younger the victim and colder the water, the better the chances for survival.
3. Victim will appear to be dead.
4. Don't give up. Administer CPR and notify EMS.

E. Handle all cold-water victims with extreme care. Prevent further heat loss but do not try to quickly rewarm.

Tab 8 - Boat Orientation and Marlinspike

24-hour Motorboat Operator Training Manual

I. **Outboard motorboat** characteristics and starting procedures.

A. Make a visual check of the vessel's exterior and interior appearance. Look for anything out of the ordinary.

B. Identify all characteristics of the boat and motor.

1. Hull design. See "Boats and Boat Maintenance" tab for details and characteristics of different hull designs.

2. Outboard motor. See "Boats and Boat Maintenance" tab for more information on outboard motors.

3. Controls.

a. Throttle Cables.

b. Steering Cables.

c. Trim.

d. Bilge Pump/Switch.

e. Master Battery Switch.

f. Fuses.

g. Lights.

h. Horn.

i. Fuel Gauges, Vents.

j. Meters and Gauges.

k. Radio and PA System.

4. Check safety equipment required by U.S. Coast Guard, U.S. Army Corps of Engineers, and state. See "Equipment Requirements" tab for detailed information on safety equipment.

C. Starting Procedures.

1. Turn on master switch. Check that electrical equipment is on and functioning.

2. Raise lower unit to check the prop and skeg.

3. Check to ensure that there is adequate fuel for mission. Open the vent on portable fuel tanks.

4. Squeeze primer bulb to prime the fuel line.

5. Check level of oil in oil injector.
6. Place shifter in neutral.
7. Raise neutral warm up lever or engage neutral throttle.
8. Start engine.
 - a. Turn key to start.
 - b. Press choke button or push in on key-operated choke and hold for 5 to 10 seconds. Some small outboards have a pullout choke lever.
 - c. After engine starts, disengage choke.
9. Check water pump operation, pressure gauge or telltale stream. Listen for unusual noises in engine.
10. Warm up engine for 2-3 minutes at no more than 1000 rpm's.
11. Return engine speed to idle before shifting, check forward and reverse gears using quick, firm motion.
12. Test kill switch for proper operation
13. Once you are underway, monitor gauges and shut down the engine if any reading is outside of the safe range or if you hear any unusual engine noise.
14. Trim engine for maximum performance at desired speed.

II. **Inboard and Inboard/Outboard motorboat** characteristics and starting procedures. See "Boats and Boat Maintenance" tab for more information on inboard and inboard/outboard motors.

A. Make a visual check of the vessel's exterior and interior appearance. Look for anything out of the ordinary.

B. Identify all characteristics of the boat and motor.

1. Hull design. See "Boats and Boat Maintenance" tab for details and characteristics of different hull designs.
2. Inboard/Outboard motor. See "Boats and Boat Maintenance" tab for more information on inboard and inboard/outboard motors.
3. Controls.
 - a. Throttle Cables.
 - b. Steering Cables.
 - c. Trim.
 - d. Bilge Pump/Switch.

e. Master Battery Switch.

f. Fuses.

g. Lights.

h. Horn.

i. Fuel Gauges, Vents.

j. Meters and Gauges.

k. Radio and PA System.

4. Check safety equipment required by U.S. Coast Guard, U.S. Army Corps of Engineers, and state. See "Equipment Requirements" tab for detailed information on safety equipment.

C. Starting Procedures.

1. Open the engine cover and leave open until all checks are completed.

2. Smell for gas fumes in the bilge.

3. Turn on master switch. Check that electrical equipment is on and functioning.

4. Turn on the bilge blower. Operate blower for at least 4 minutes before starting engine.

5. On an inboard/outboard motor, raise lower unit to check the prop and skeg.

6. Check engine.

a. Check oil level and fill if necessary.

b. Check coolant level and fill if necessary.

c. Check belts for condition and tension.

d. Check power steering fluid and fill if necessary.

e. Check carburetor and fuel lines for leaks.

f. Check backfire flame arrestor.

g. Check bilge pump for operation and check bilge for presence of fluids and fumes.

h. Check to ensure that there is adequate fuel for mission.

7. Place shifter in neutral.

8. Engage neutral throttle.

9. After the bilge blower has operated for at least 4 minutes and you have "sniff tested" the engine compartment for fumes, start the engine

- a. Turn key to start
 - b. Press choke button or push in on key-operated choke and hold for 5 to 10 seconds.
 - c. After engine starts, disengage choke.
10. Check gauges. See owner's manual for specific information.
- a. Oil pressure should be a minimum of 20 PSI.
 - b. Water temperature should be monitored as the engine warms up.
 - c. Volts/Amp meter should be charging from 0-30 amps at 1500 rpm and from 12-14.5 volts at 1500 rpm.
11. Listen to engine for unusual noises.
12. Warm up engine for 2-3 minutes at 600 rpm's.
13. Notify dispatch/project office of Float Plan and number of people on board.
14. Fill in beginning of logbook entries.
15. Return engine speed to idle before shifting, check forward and reverse gears using quick, firm motion.
16. Test kill switch for proper operation.
17. Once you are underway, monitor gauges and shut down the engine if any reading is outside of the safe range or if you hear any unusual engine noise.
18. Trim engine for maximum performance at desired speed.

III. **Refueling procedures.** No smoking during any refueling procedures.

- A. Place fenders over the side to protect hull from damage of bumping against fuel dock.
- B. Secure vessel to dock.
- C. Turn off all electrical switches off including the bilge blower.
- D. Close all hatch covers.
- E. Remove portable fuel tanks from vessels and fill portable tanks on dock.
- F. Refuel outboard engines in 6 to 12 gallon increments to ensure proper fuel/oil ratio mixture. This does not apply to oil injected outboards.
- G. Make sure gas hose nozzle is in constant contact with fuel inlet to prevent static discharge.
- H. Clean up any fuel spills.
- I. Open engine cover on inboard/outboard engines, smell for fumes and look for fuel leaks. Leave engine cover open until engine is running.

- J. Check oil level and fill if necessary.
- K. Check battery connections and fluid level.
- L. Turn on master battery switch.
- M. Operate bilge blower for 5 minutes.
- N. Enter fuel amount in logbook.
- O. If possible, walk the boat down the dock away from the fuel pumps.
- P. Start the engine.
- Q. Check gauges for proper operation.
- R. Do not transmit on the radio while refueling.

IV. **Getting underway.**

- A. Before casting off the mooring lines check the following.
 1. Check your immediate surroundings, current weather and weather forecast.
 2. Check for hazards and obstructions to vessel movement.
 3. Check the direction of the wind and current.
 4. Check for the presence of other boats moored or operating nearby.
 5. Secure all loose gear.
 6. Notify dispatch/project office of Float Plan and number of people on board.

B. Cast off lines and slowly pull away from the dock. Watch your vessel's stern when pulling away from the dock.

C. Use a bow or stern spring line with the assistance of the wind or current when appropriate.

D. Take in fenders once you are clear of the dock.

V. **Marlinspike Seamanship** is that portion of nautical knowledge that deals with the use of line to secure boats and equipment together. When "rope" is brought and used aboard a boat, it becomes known as "line".

A. The following are the most used knots aboard recreational boats.

1. Overhand Knot. This is the simplest knot.

2. Figure Eight Knot. This knot is ideal as a stopper to keep rope from running out of tackle or a pulley.

a. Make an underhand loop, bringing the end around and over the standing part.

b. Pass end under, then up through the loop.

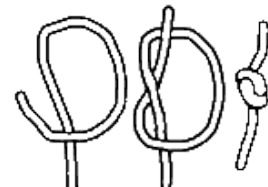

c. Draw up tight.

3. Two half hitches. This reliable knot is quickly tied and is the hitch most often used in mooring.

a. Pass end of rope around post or other object.

b. Wrap short end of rope under and over long part of rope, pushing the end down through the loop. This is a half hitch.

c. Repeat on long rope below first half hitch and draw up tight.

4. Square Knot (Reef Knot). This knot is used in simple applications to tie together two lines of the same diameter. It is easily tied and will not jam.

a. Pass left end over and under right end. Curve what is now the left end toward the right and cross what is now the right end over and under the left. "Left over right, right over left".

b. Draw up tight.

5. Clove Hitch. This knot is the "general utility" hitch for when you need a quick, simple method of fastening a rope around a post, spar or stake.

a. Make a turn with the rope around the object and over itself.

b. Take a second turn with the rope around the object.

c. Pull the end up under the second turn so it is between the rope and the object. Tighten by pulling on both ends.

6. Anchor Bend (Fisherman's Bend). This knot is used to secure a rope or a line to an anchor.

a. Pass two loops through ring.

b. Place free end around standing line.

c. Pass free end through loops.

d. Complete by making half hitch.

7. Cow Hitch (Lark's Head). The Cow Hitch is used to loosely attach a rope to a spar or ring. The knot has two redeeming features, it is easy to tie, and it does not jam. However, it will slip fairly easily along the spar, and may slip undone when tied using man-made fiber ropes.

8. Sheet Bend. This knot is used to tie two lines together, especially if they are of different sizes or textures. The knot should be tied with both ends coming off the same side of the bend, as illustrated here.

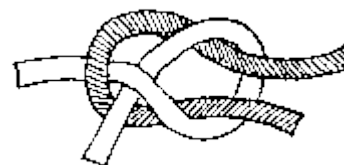
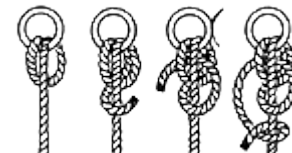
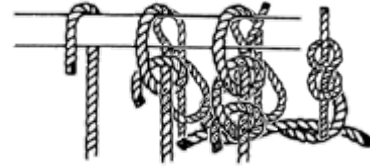

9. Bowline. Also called the "king" of knots, the bowline is very versatile. It is used to form a temporary loop in a line, which may then be put over a piling or cleat. It can also be used to attach a line to an eye. This knot won't slip or jam.



- a. Make the overhand loop with the end held toward you, then pass end through loop.
- b. Now pass end up behind the standing part, then down through the loop again.
- c. Draw up tight.

10. Rolling Hitch. This knot is used to tie a small line to the standing part of a larger line, in such a manner that the first rope can be easily slid along the second. The knot can be considered a clove hitch with an additional turn. When tension is applied and the ropes form a straight line, the rolling hitch will lock onto the first rope. When the tension is released, the hitch can be loosened and slid along the first rope to a new location. The tension must be applied on the side of the knot with the extra turn.

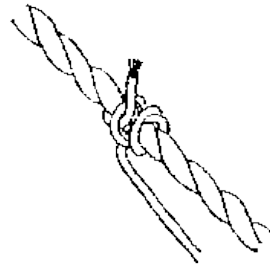

11. Cleat Wrap. This knot is needed by every boater to attach a line to a standard cleat on a boat dock or on the boat itself.

- a. Take the line to the ear of the cleat furthest from where the line comes from the boat (or load).
- b. Take one wrap around the base of the cleat and then start a figure eight across the top of the opposite ear.
- c. Finish with a half hitch turned under so that the line is coming away from the cleat in the opposite direction from which it came in.



12. References: <http://www.animatedknots.com/>
<http://www.sacdelta.com/safety/knots/>

B. Mooring a vessel. At least three and preferably four lines should be carried aboard for docking. A bow line to secure the bow; a stern line to secure the stern, and at least one spring line to reduce fore-and-aft movement. The diagram below shows four lines used. Although the stern line will keep the boat from moving forward too much, to be safe a fourth spring line running from the dock cleat forward should be used.

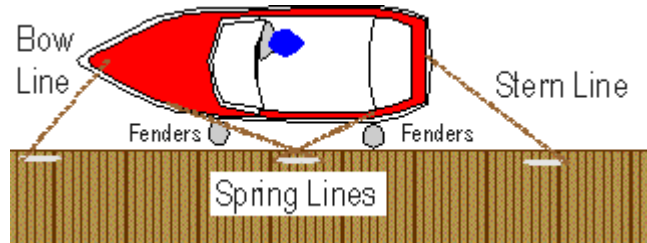

C. Several types of line are used aboard both power and sailboats, including those made of natural fibers, synthetic materials and wire. As a boater, you will be handling line every time you leave the dock. So, it is important that you understand the best uses for each type of line. And make sure to take good care of your line, by inspecting it regularly for deterioration and chafing.

Tying knots or hitches in the same place often will cause that part of the line to weaken. Occasionally switch the line ends (like rotating your tires) and try to tie knots and hitches in different areas of the line. Prolonged exposure to rust, dirt, sand or mud deteriorates rope. Any stiff or hard lines should be replaced. Whichever lines you choose to use, make sure they are kept out of the sun when not in use, clean, unfrayed, dry and coiled neatly. Don't leave knots in a stowed line for long periods of time. To clean rope, scrub it with a solution of liquid soap and water. Dry completely before storing.

1. Natural Fibers. The most versatile of natural fiber line is manila, which is noted for its strength and flexibility. It is used for mooring and anchor lines, and for running rigging such as sheets to control sails. Manila line shrinks when wet, and will rot if stowed wet. If used in saltwater, manila line should be thoroughly washed with fresh water, and should always be dried before stowing. Keep lines away from heat sources, acids and oils.

2. Synthetic Fibers.

a. Nylon line is excellent for use as anchor rope, and docking and towing lines. It is the strongest line for its size, and can stretch up to 40% of its length. It can be stored wet, but should be regularly washed with fresh water and mild detergent.

b. Polyester line, although 10% weaker than nylon and not as flexible, has some excellent uses. These include running rigging, sheets and halyards. Make sure to use chafing gear with polyester line, as it tends to chafe easily.

c. Polypropylene line is the least costly of synthetic lines. It has a hard texture that slips on cleats and can cut skin. Because it floats, it is the best line to use for towing a water skier. Polypropylene deteriorates when exposed to sunlight.

3. Wire Rope. Steel wire is used for standing and permanent rigging and halyards for hoisting sails. It is very strong, but has little stretch. Inspect wire for corrosion and kinks and keep it well lubricated.

D. There are several ways to properly stow your line once it has been cleaned. The simplest way is to coil the line in a clockwise direction. You can then either leave it laying on deck, or hang it by tying it up with extra line or nylon straps. Or you can "flake" line by simply laying it in the form of a figure eight.

When stowing line, consider how soon you'll need it again, in order to leave it accessible, and make sure it is not left where it will interfere with the boat's operation.

E. Whipping. Cutting a line may cause it to start to fray and unravel at the cut end. Whipping is the traditional way to protect the ends of your lines. Whipping is accomplished by tightly wrapping small line or lacing twine around the end of the cut line. The width of the whipping should approximate the diameter of the cut line.

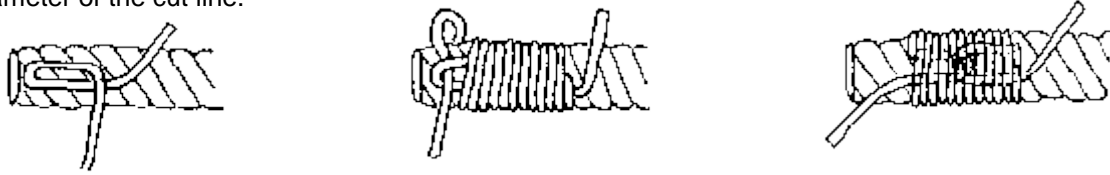

Ends of rope can also be sealed by cutting the line with a hot knife to seal them, wrapping some adhesive tape at each end, or dipped in an air-drying liquid plastic. When buying line, you can buy pre-packaged lengths that are already whipped.

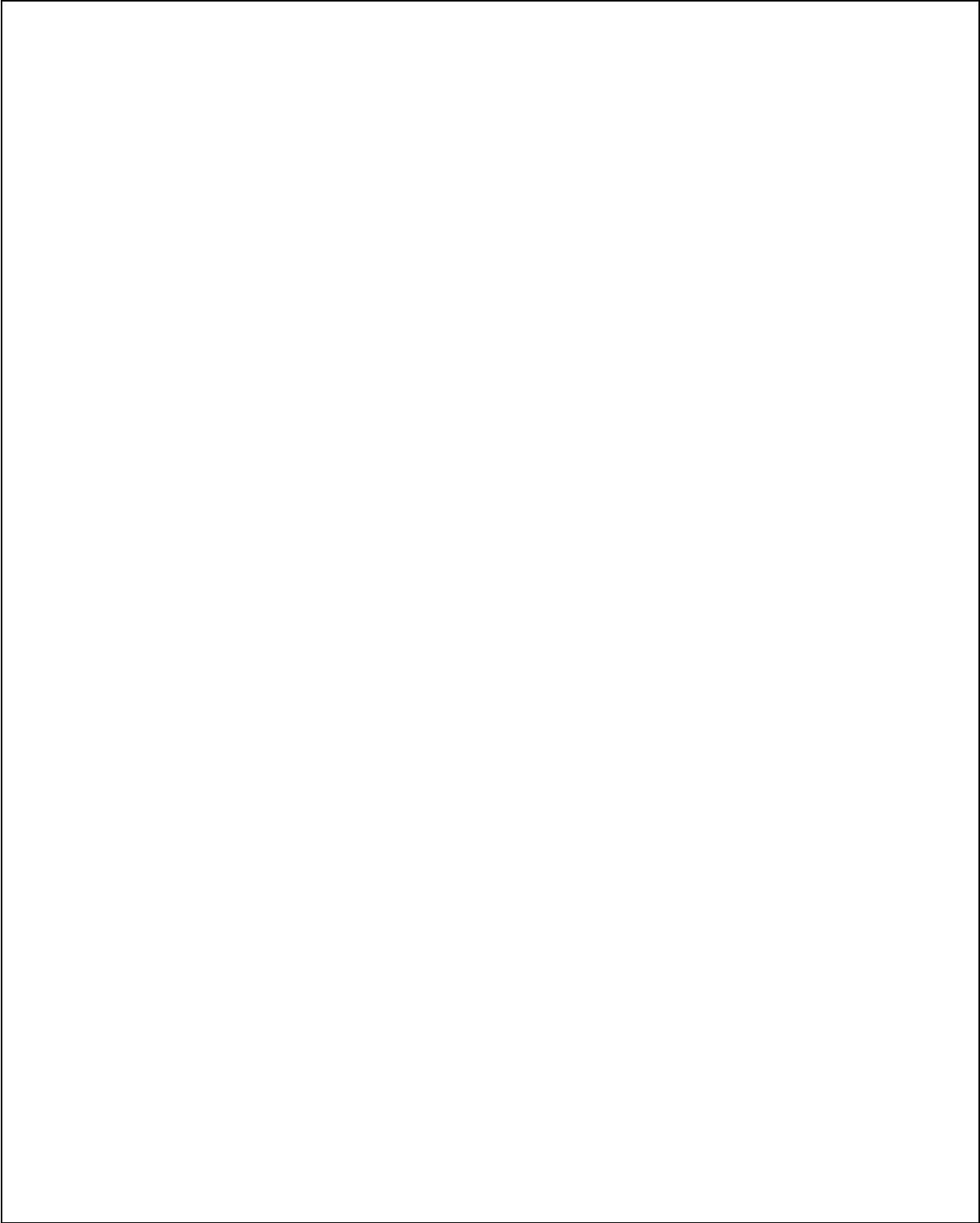

Tab 9 - Boat Operators Inspection and Checklist

24-hour Motorboat Operator Training Manual

The *Daily Operators Inspection Checklist* is to be used each time a motorboat and/or trailer are put into use.

ON RETURN – AFTER OPERATION

Inspection Criteria	Date								
Fuel and oil in motor and full?									
Spare fuel and oil containers are full?									
Wheel blocks are in place?									
Trash is removed?									
Boat cleaned (in same or better condition than prior to your use)?									
Equipment secure in proper locations?									
Life jackets (PFDs) and throw bags are dried out?									
Inspect/report damage and needed maintenance									
Boat key and credit card turned in?									
Flush out lower unit as needed?									
Float Plan is updated for return and completed?									
Float Plan is turned in and filed?									
Comments									

Print Name _____ Signature _____	Print Name _____ Signature _____	Print Name _____ Signature _____	Print Name _____ Signature _____	Print Name _____ Signature _____	Print Name _____ Signature _____	Print Name _____ Signature _____	Print Name _____ Signature _____
-------------------------------------	-------------------------------------	-------------------------------------	-------------------------------------	-------------------------------------	-------------------------------------	-------------------------------------	-------------------------------------

Tab 10 - Course Familiarization/Maneuvering

24-hour Motorboat Operator Training Manual

I. Course description options.

A. Serpentine Course. The purpose is to:

1. Develop relationships to fixed objects while maneuvering to port/starboard, after efficiently getting the boat on plane.
2. Become familiar with the steering capabilities of the boat
3. Become familiar with the steering and throttle coordination of the boat.
4. Learn how to prevent cavitation.

B. Transition Course. The purpose is to:

1. Develop ability to transition between serpentine course and slalom course.
2. Master skills necessary to successfully complete the course, making all turns.

C. Emergency Stop Mode Maneuver. The purpose is to:

1. Practice maneuvers necessary to avoid a collision while at safe speed so that one can take proper and effective action to avoid collision and be stopped within a distance appropriate to the prevailing circumstances and conditions. This is based on the maneuverability of the vessel with special reference to stopping distance and turning ability in the prevailing conditions.
2. Practice decision-making.
3. Practice smooth steering and throttle control.
4. Heighten the operator's perception of obstacles in the water.
5. Practice making emergency stops by reducing speed during proper course change.
6. Develop skills to judge distance, time and boat speed.
- 7. Power should be reduced immediately to idle while turning the helm. The engine is shifted to neutral only after the turn is complete.**

D. Docking Maneuver. The purpose is to:

1. Develop skills necessary to dock a boat on the port and starboard sides to a fixed dock and a floating vessel.
2. Develop skills necessary to pull forward into a boat slip.
3. Develop skills necessary to back into a boat slip.

E. Optional buoy pattern courses can be substituted for buoy pattern courses indicated above if local conditions or limitations of training site warrants change. The purpose of these optional course Star Pattern and Maneuvering Courses is to: Provide alternate buoy courses for instructors to use when required by local circumstances.

1. Develop relationships to fixed objects while maneuvering to port/starboard.
2. Become familiar with the steering capabilities of the boat.
3. Become familiar with the steering and throttle coordination of the boat.
4. Learn how to prevent cavitation.
5. Practice docking and backing maneuvers.
6. Develop skills for selecting and engaging the correct gear for docking, backing and cruising.

B. Course rules and regulations.

1. If a "Code Red" is declared, all boats must immediately come to a stop and remain stopped until directed by an instructor.
2. Only one boat will be on a maneuvering course at a time unless directed otherwise by an instructor.
3. Type III inherently buoyant PFD's must be worn by students in boats at all times.
4. A working radio must be carried in each boat and be turned on at all times.
5. A kill switch is required in each boat. Operators must be attached to the kill switch via a lanyard when underway. When navigating the maneuvering courses the instructor may have a second lanyard attached to the student lanyard.
6. At least one instructor will be in boats containing students at all times.
- 7.7 When conducting the emergency stop maneuvering course there will be one instructor and one student in the boat.
8. Boat operators will maintain a safe and controlled speed at all times.

II. Course Maneuvering.

A. Serpentine Course

Students will practice operation of a boat through 8 gates, while on plane, at safe cruising speed.

B. Transition Course

Students will practice operating the boat on plane through four serpentine gates then transition into a six buoy slalom course.

C. Emergency Stop Mode Course

1. Students will practice operations to simulate evasive maneuvers necessary to avoid a fixed object at safe speed.
2. Students will practice operations to simulate evasive maneuvers necessary to avoid a collision with another boat at safe speed.

D. Docking Maneuvers.

1. Students will practice skills necessary to dock a boat on the port and starboard side to a fixed dock.
2. Students will practice skills necessary to pull into a boat slip in forward.
3. Students will practice skills necessary to back into a boat slip.

E. Star Pattern.

1. Students will practice skills necessary to maneuver a boat in tight quarters.
2. Boats must approach star pattern, enter between buoys 1 and 2, drive forward between buoys 4 and 5, back up between buoys 2 and 3, drive forward between buoys 1 and 5, back up between buoys 3 and 4, then drive forward out of the pattern between buoys 1 and 2. On any maneuver, the boat's centerline should not drift past the buoys.

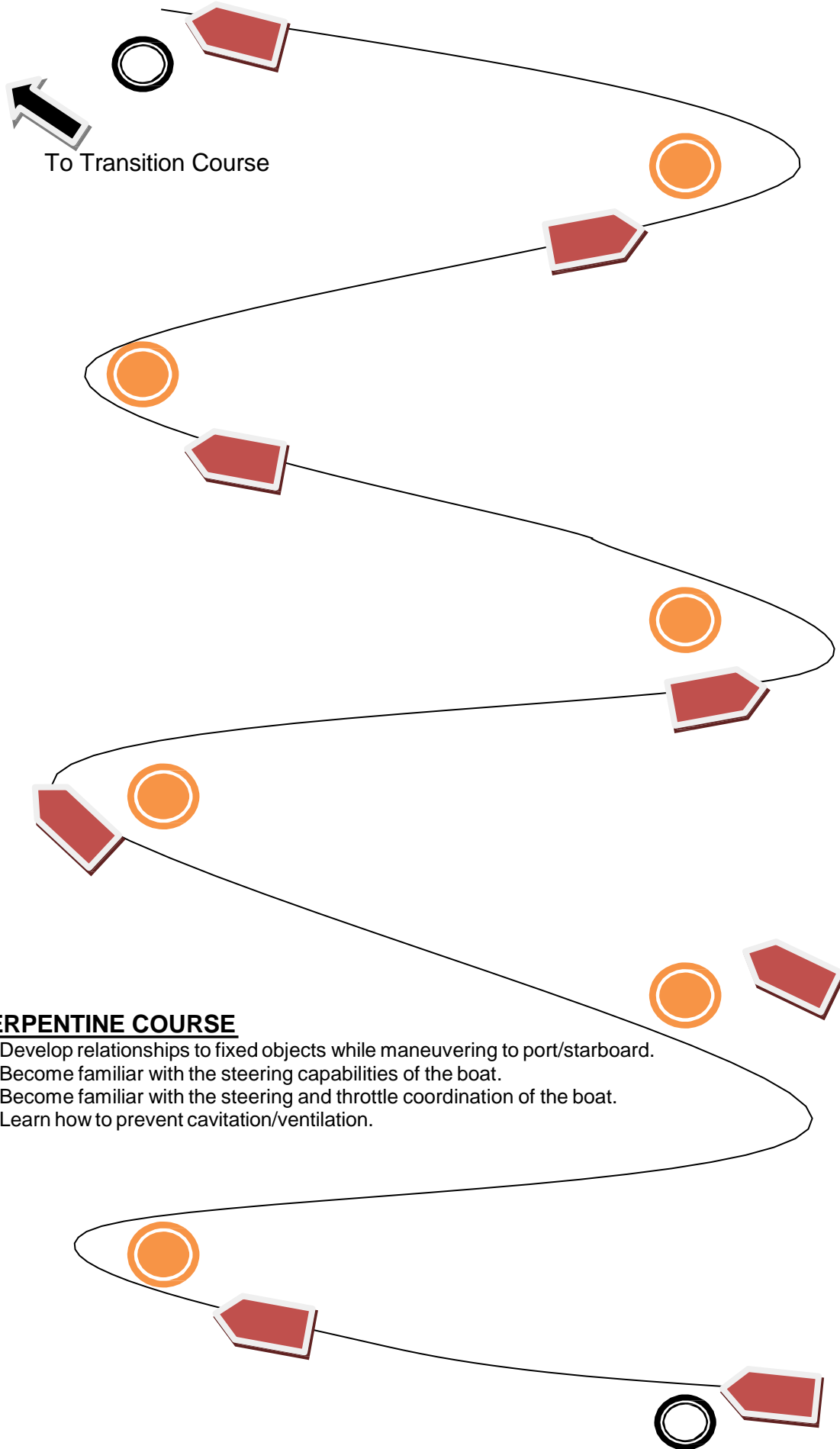

SERPENTINE COURSE

1. Develop relationships to fixed objects while maneuvering to port/starboard.
2. Become familiar with the steering capabilities of the boat.
3. Become familiar with the steering and throttle coordination of the boat.
4. Learn how to prevent cavitation/ventilation.

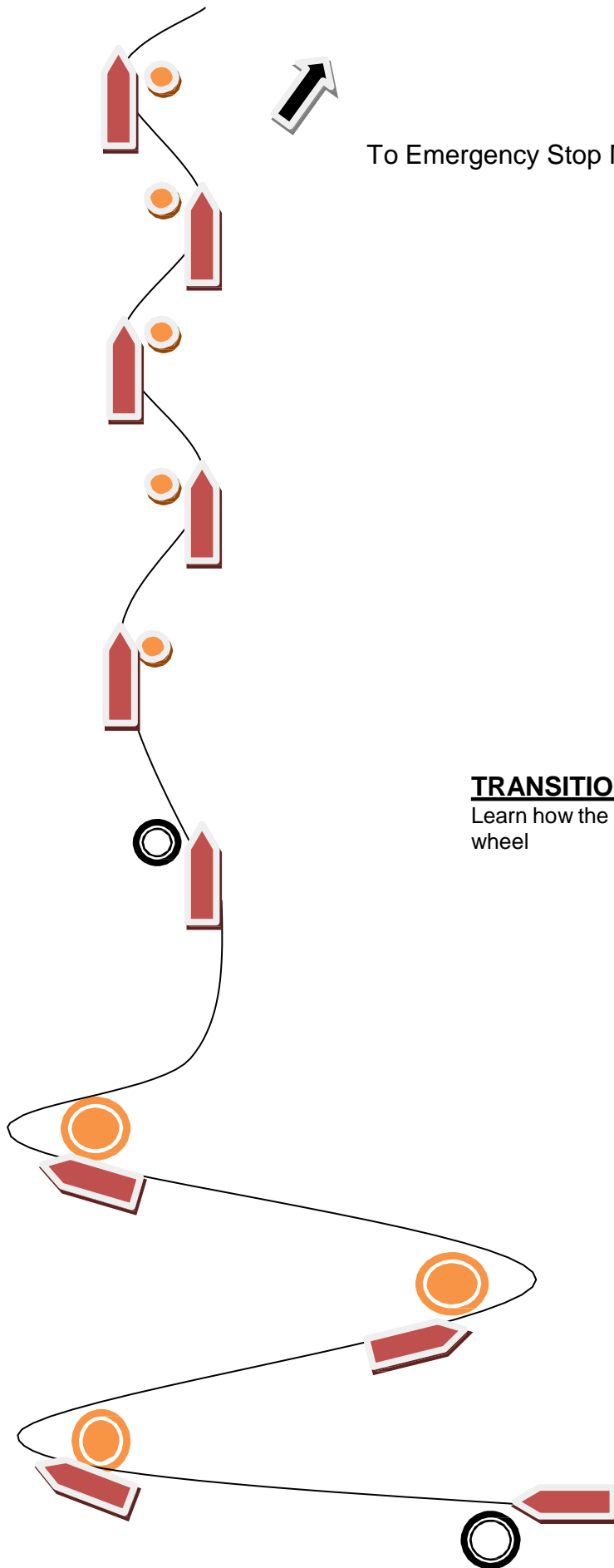

To Emergency Stop Mode Course

TRANSITION to SLALOM MANEUVERING

Learn how the boat stern responds to short turns of the wheel

Guidelines and Controls for the Proper
Instruction of the Emergency Mode Stop

Maneuver:

NOWS Standards “Emergency Mode Stop

- Operator is given “port’ or “starboard” direction prior to getting the boat underway
- Operator brings boat on to plane at safe speed and heads for a buoy downrange
- Instructor will give a three second count “*Ready... 3... 2... 1... Now!*”
- Operator makes a smooth 90-degree turn **while throttling down** to idle

The major difference in this modification is the when the throttle reduction occurs. Reducing throttle while making the turn will eliminate the “recoil” that took place under the old maneuver.

View the video at <https://www.youtube.com/watch?v=f91u5JfIEOs>

- **Instructor must operate the training boat prior to using the boat for instruction** and perform this maneuver at varying safe speeds. This will make them familiar with the boats handling capabilities.
- **Instructor must know the minimum and maximum RPM range where the boat can safely execute the maneuver.**
- **The maneuver must always be done using a fixed point of reference for the turn.**
- **One student and one instructor on the boat** shall be the only way this maneuver is trained.
- Verify the kill switch (engine cut-off device) is operable prior to getting underway and the operator is tethered to the device.
- A **verbal walk trough of the maneuver with the student prior to demonstration** should occur to explain the mechanics of the move, how the boat will react and the forces that will occur when the concurrent turn and throttle down happen
- **Instructor will point out potential hazards** and identify three points of contact for stability.
- **Ensure the operator is confident, willing and able to attempt the maneuver.** Not intended to scare or intimidate operators, but to build confidence and understanding of the boats capabilities. New operators with limited experience may require more boat operation before attempting this maneuver.
- **Ensure operator understands the verbal commands** that will be given to complete the maneuver. “*Port or Starboard*” “*Ready... 3... 2... 1... Now!*”
- **The instructor may make use of the double lanyard system to the kill switch.**
- **The instructor should demonstrate this maneuver multiple times at various safe speeds and then discuss with the student the different reactions that occurred.**
- When students first operate, they will proceed on plane at the lowest RPM where the boat will execute the maneuver.
- **As confidence builds the RPM’s can be increased as long as it is at safe speed** and they demonstrate the proper techniques to execute the maneuver.
- **After each run, conduct a review** of improvements or tips to help the operator understand the emergency stop maneuver for future operation/re-certifications.

Emergency Stop Mode

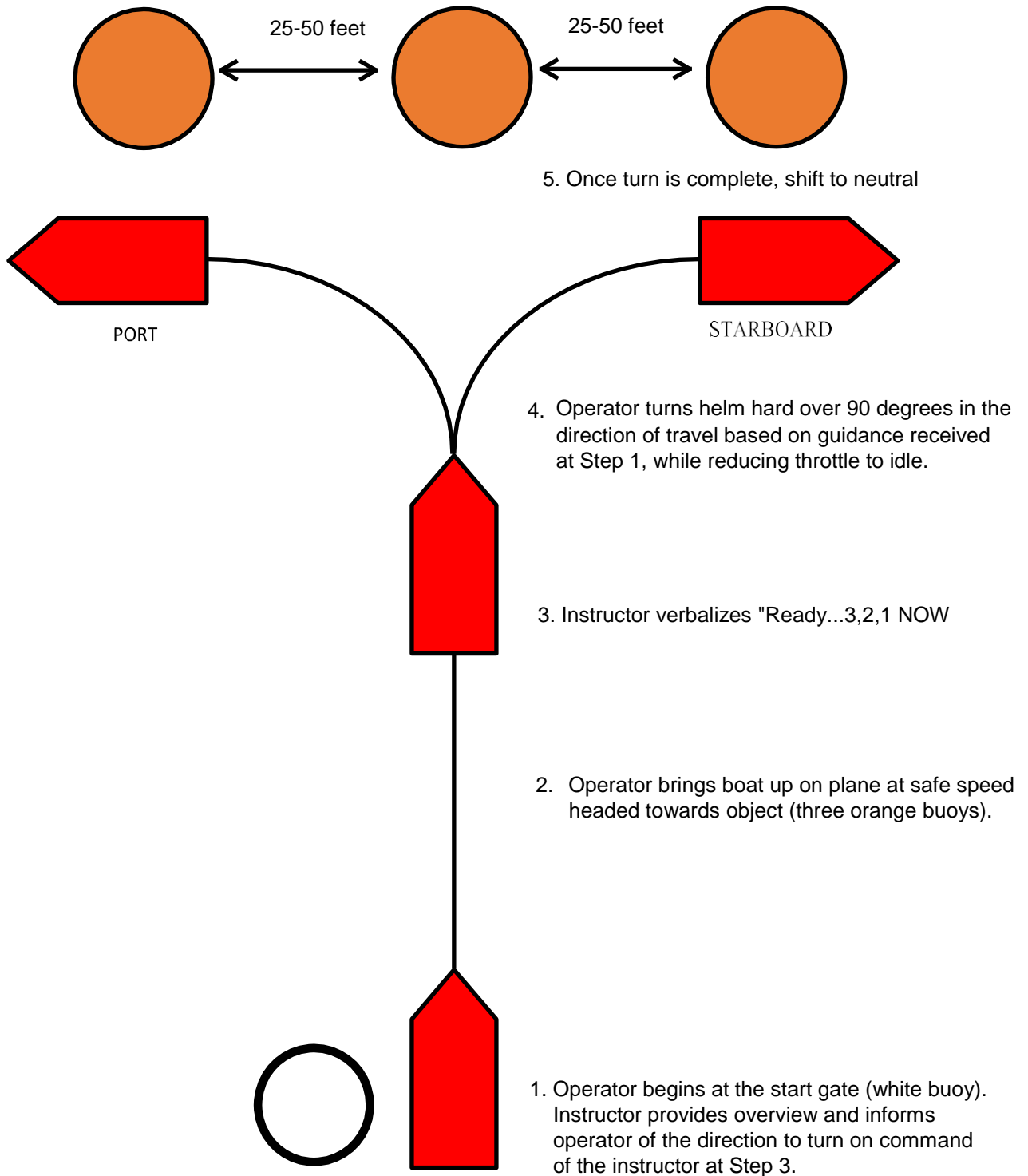

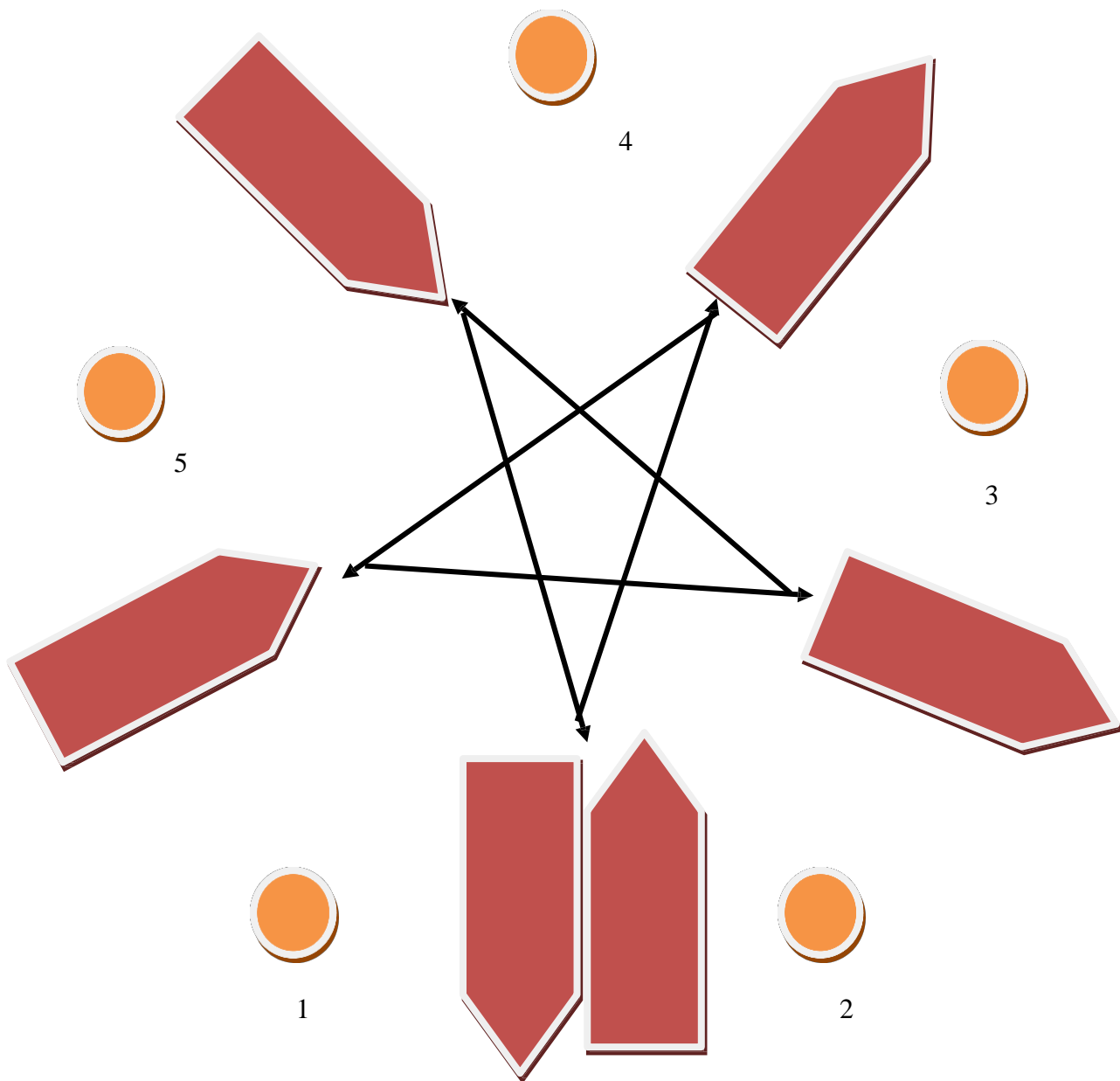

STAR PATTERN MANEUVERING

1. Skills necessary to maneuver a boat in tight quarters.
2. Boats must approach star pattern, enter between buoys 1 and 2, drive forward between buoys 3 and 4, back up between buoys 1 and 5, drive forward between buoys 2 and 3, back up between buoys 4 and 5, then drive forward out of the pattern between buoys 1 and 2. On any maneuver, the boat's centerline should not drift past the buoys.

Tab 11 - Towing and Anchoring

24-hour Motorboat Operator Training Manual

I. Towing Basics. The first rule of good boating when assisting another vessel is to keep your boat from joining the other craft in its trouble.

A. Towing Equipment.

1. Towlines. 75 feet of $\frac{1}{2}$ or $\frac{3}{4}$ inch double-braid line is recommended as a towline.

a. Double-braid line is the preferred line for towing. This line is stronger than nylon line of the same size and will not kink. Double-braid line has enough elasticity to cushion shock loads, but not so much as to create a snap-back hazard. Double-braid line does not float, therefore you must watch it to avoid tangling it in the towing vessel's propeller.



b. Three-strand twisted nylon line exhibits excessive stretch and can snap back dangerously if the line breaks under load. This line should not be used for towing if it can be avoided.

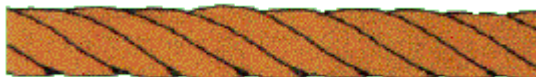

c. Polypropylene line has very little elasticity and shock loads are transferred to cleats and fittings on both the towed and towing vessels. This line floats and is a very visible bright yellow color. Polypropylene line has less strength than double-braid line and is stiff, making it more difficult to stow and handle. Polypropylene line also abrades easily. This line is only suitable for towing light loads in protected waters.

2. Hooks or karabiners. Ensure that breaking strength is greater than the strength of the line.

3. Towing Bridles are used to divide the strain of the tow between two cleats or fittings on the towing vessel and to help improve control. The two legs of the towing bridle are connected to the stern cleats or transom eyebolts. The length of each leg of the bridle should be at least $2\frac{1}{2}$ times the width of the towing vessel's transom. Bridles should be rigged ahead of time and should be made using the same line as the towline.

4. Miscellaneous mooring lines, fenders, boat hook, lights, knife or ax.

5. A tow bag can be used to keep the towing bridle and towline clean, dry and free from knots. Tow bags may also make it easier to pass the towing line to the towed vessel and to keep the line from fouling in the propeller while the line is being paid out.

B. Safety.

1. Start tows easy.

a. Use a steady pull.

b. Slowly increase speed, but stay below planning speeds for both boats.

c. Stay "in step" with waves. Adjust the length of the towline to keep both boats on the crest or in the trough of waves at the same time. This will minimize the strain on the towline and the fittings of each vessel.

2. Do not stand in line with the towing line. Lines can break under the stress of towing. Cleats and blocks can also pull loose from either of the vessels. If a line breaks or pulls loose while under pressure, the line will snap back with tremendous force and can hit and injure anyone in its path.

3. Be very careful when rigging the tow to keep extremities from being crushed between the two vessels.

4. Watch wind and wave conditions to adjust tow speed and rope length.

5. Avoid sudden maneuvers and make wide turns.

6. Don't let the disabled boat "rear-end" you when you slow down or pull into a dock.

7. Shorten the line for more maneuverability when needed.

8. Think ahead when you are coming into a marina or other crowded area. Should you change to a different type of tow?

9. Be ready to cast off or cut the towline if the disabled vessel starts to sink or endanger you or your vessel.

10. Velcro flags or plastic surveyor ribbon may be attached to the towline to make it more visible and to help prevent other vessels from cutting in between the two vessels and hitting the towline.

11. If necessary, remove all persons from the vessel to be towed.

12. Have all persons on board put on PFDs and sit down in an approved seat.

13. Do not use a line belonging to the boat you are towing. There is no sure way to know its condition.

14. Always assess the condition of the boat, its design, the trim and load of the boat, the number of people on board and their condition, before initiating any tow.

C. Tow Operational Plan. Refer the tow to a towing service if possible. Otherwise:

1. Survey the scene and evaluate the conditions. Has the operator asked for assistance? Does the disabled boat have anchors out? Does the disabled boat appear to be in good condition and structurally sound?

2. Talk to the operator of the disabled vessel.

a. Evaluate the skipper. Does he appear sane and in control?

b. Where does the skipper wish to be towed? In most circumstances you should only tow a disabled vessel to the closest safe mooring.

c. Prepare the tow system and instruct the skipper what to do.

d. Issue all special instructions to the skipper.

(1) Ensure that all people are wearing PFDs.

(2) All passengers should be seated in the proper area and ensure that the vessel is properly loaded.

(3) Instruct the skipper to steer with you.

(4) Ensure that there is communication between boats, using either hand signals or radio (VHF or CB).

II. Towing Points.

A. Towing points on the disabled boat.

1. The bow eye is the best choice if it is in good condition.

2. Can also use a Sampson post if one is present on the disabled boat.

3. On sailboats, you can use the foremost mast unless it is a "stepped" (removable) mast.

4. As a last resort, use bow cleats. But be careful, most recreational boats are not equipped with adequately reinforced cleats. To tow using bow cleats, you should rig a reversed "Y" bridle. The length of the "Y" section should be a minimum of three times the width of the disabled vessel. This will lessen the strain of the pull on the bow cleats. Be careful of the cleats pulling out.

B. Towing points on the towing vessel.

1. Transom eyebolts (also called lifting eyes) are usually well built and reinforced, but need to be checked to make sure.

2. Stern cleats can also be used. They must be heavy duty and mounted through the deck with reinforced backing. If you are in doubt about the stern cleats, check with the manufacturer. Reinforced stern cleats are standard equipment on some commercial grade vessels.

3. A towing bit is the best towing point, but is not available on most boats.

C. Securing the towline to towing points.

1. Use quick-release arrangement if possible.

2. When securing to a bow eye or transom eye, use a loop in combination with a karabiner or snap hook. Loops can be tied in using a bowline or double figure eight.

3. When securing to reinforced cleats, use a loop or standard cleat wrap.

III. Types of tows.

A. Off stern with a single rope.

1. Easy to rig.
2. Good for long offshore towing.
3. Good shock absorbency.
4. The length of the tow rope can be changed easily.
5. The towing vessel needs very strong cleats or towing bit.

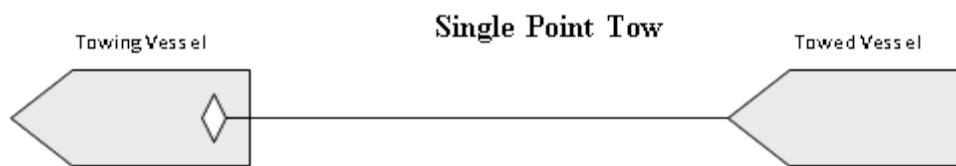



B. Off stern using a single rope with a "Y" bridle.

1. Used in towing outboards, inboards, and inboard-outboards.
2. Good for long offshore towing.
3. Good shock absorbency.
4. The bridle must be very strong and should be pre-made.
5. The towing vessel needs very strong cleats or towing bit.
6. The length of the "Y" section should be at least two to three times the width of the transom of the towboat.

Y Bridle Options

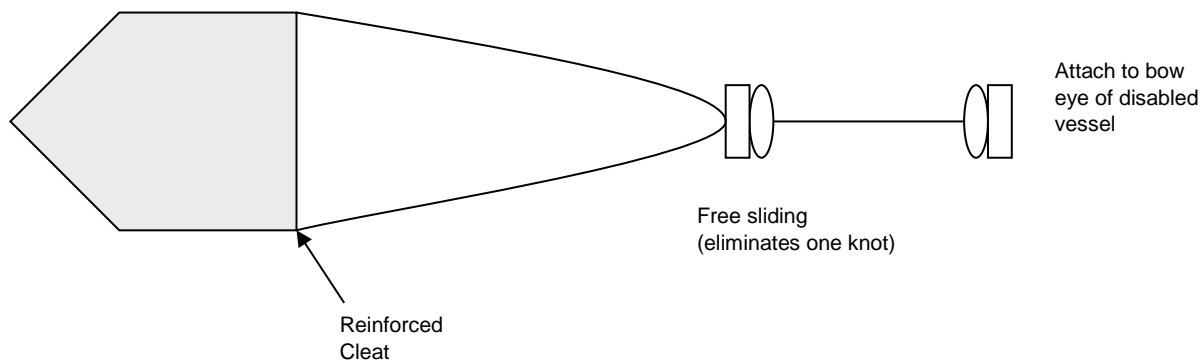
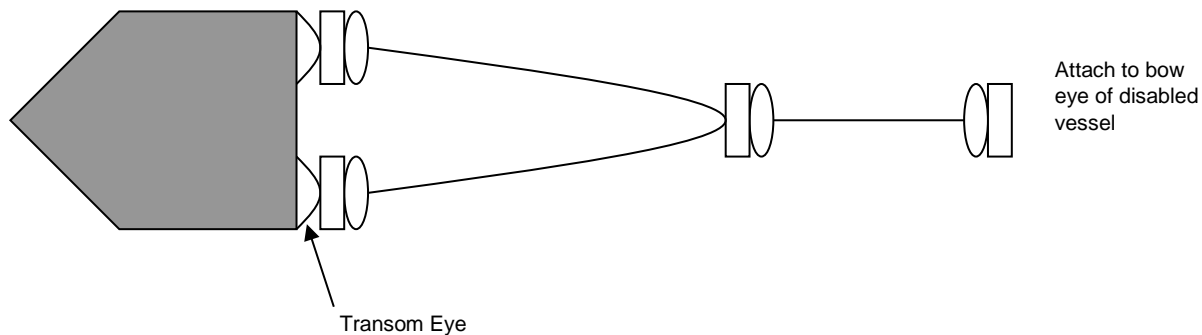
The length of the "Y" section should be at least **two to three times** the width of the transom of the towing vessel.



 Karabiner

 Line with loop

C. Off Stern using a "V" bridle.

1. This tow offers good control in confined waters.
2. The length of the tow can be changed easily.
3. The distribution of the load is good.
4. The length of the "V" section should be at least two to three times the width of the transom of the towboat.

V Bridle Options

The length of the "V" section should be at least **two to three times** the width of the transom of the towing vessel.

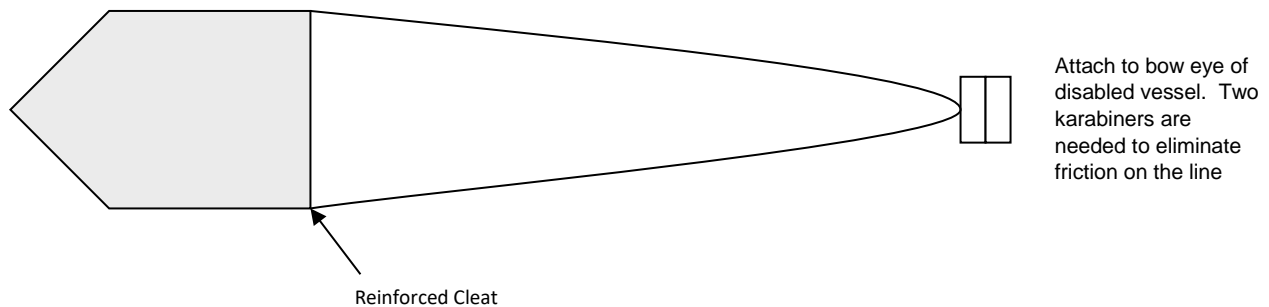
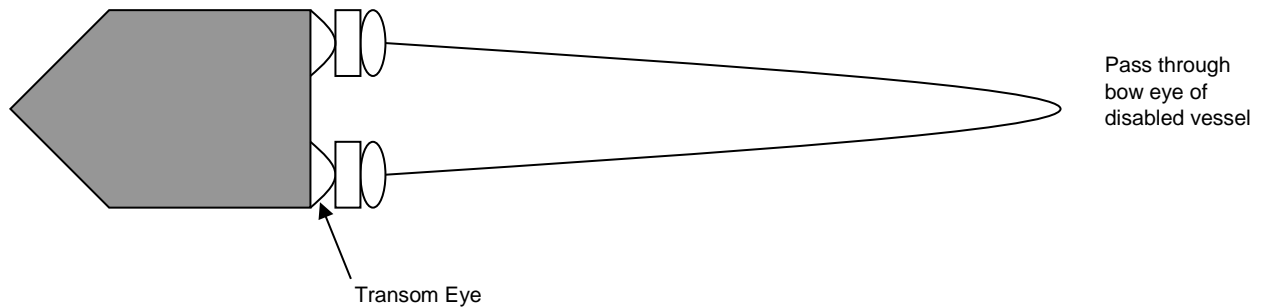

D. Alongside Tow (pusher).

1. This tow offers excellent control in confined waters.
2. Must have chafing gear to avoid damage to both vessels.
3. The towed vessel should be positioned on the port bow of the towing vessel. This allows the towing vessel to still view their danger area on the starboard side of the towing vessel.

Alongside Towing Options

Disabled vessel should be positioned on port bow of towing vessel. Option B is preferable when the disabled vessel is larger than the towing vessel. Rigging is also dependent on the availability of cleats.

Option A

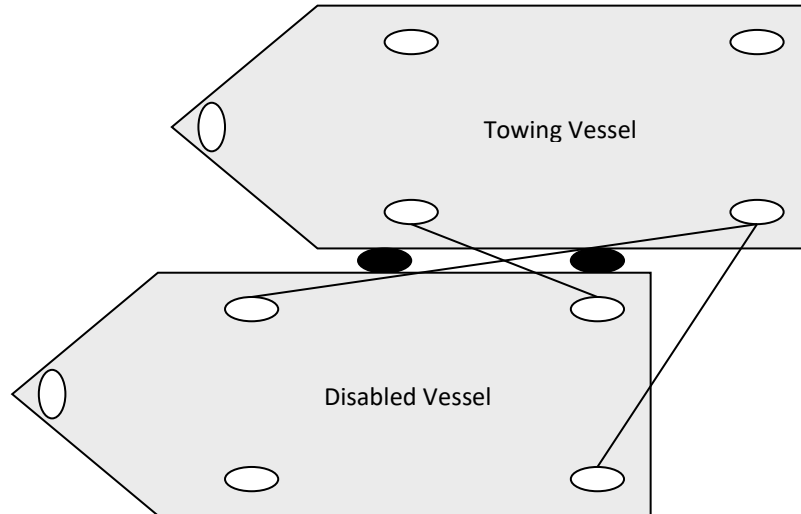

● Fender

○ Cleat

Option B

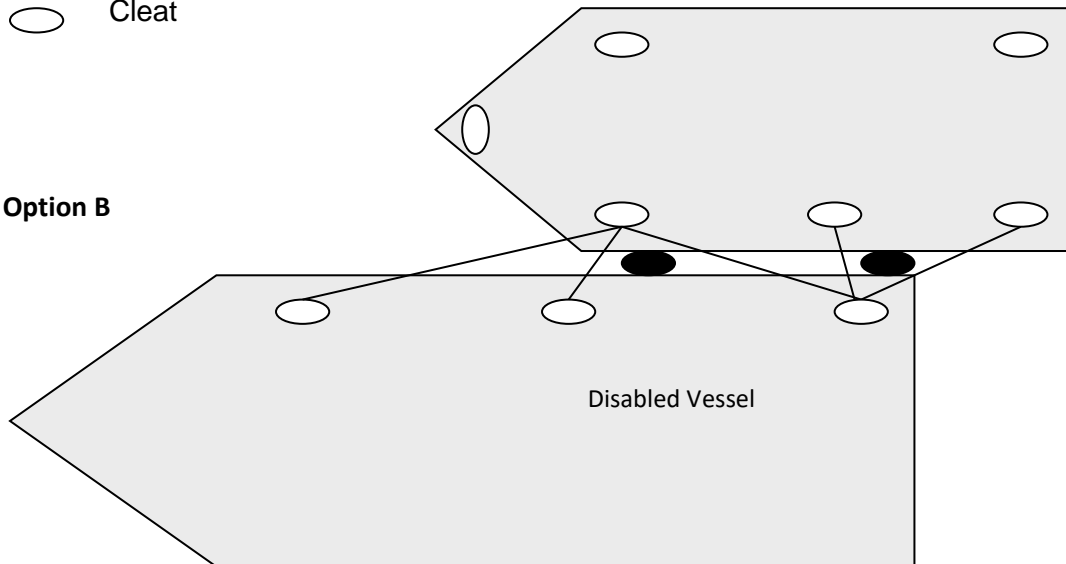

IV. Approaching and hooking up to the disabled vessel.

A. The approach is selected based on conditions at the time of the tow.

1. Parallel Approach. The parallel approach is used in good weather and when the disabled boat is anchored or when its rate of drift is slow. The towing boat approaches from the stern on the windward side of the disabled boat (if possible). Skilled boat handling is necessary at this point because the towing

boat must pass close enough to pass the towline and stop a short distance ahead of the disabled boat. The towline is passed as the amidships portion of the towing boat reaches the bow of the disabled boat.

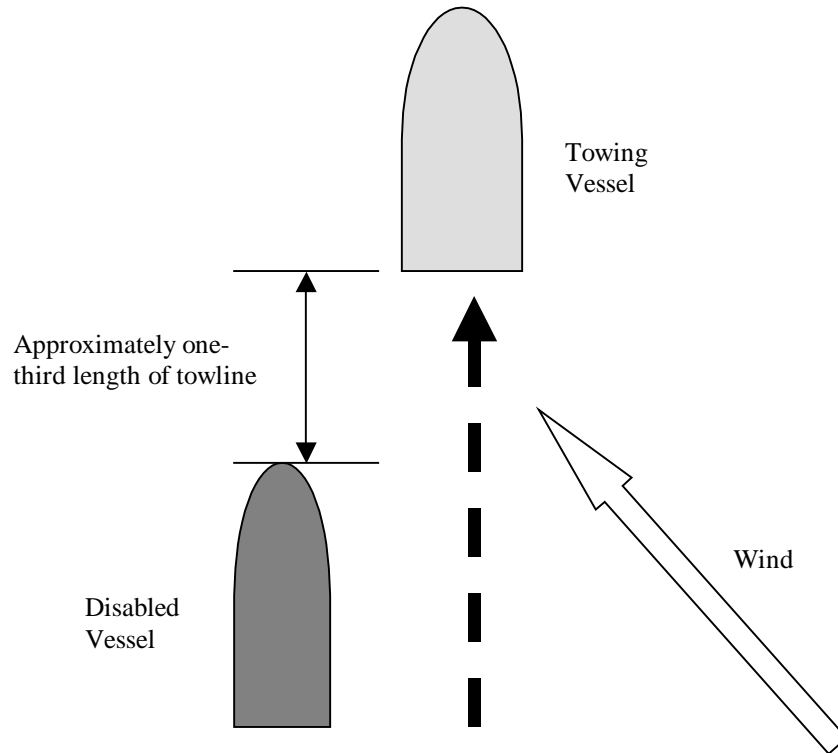

2. 45-Degree Approach. The 45-degree approach is used when there are calm to moderate sea conditions. The towing vessel approaches on a heading of about 45 degrees from the disabled boat's direction of drift. If possible, the approach should be made into the prevailing seas and/or wind. The towline is passed just as the amidships portion of the towing boat passes the bow of the disabled boat.

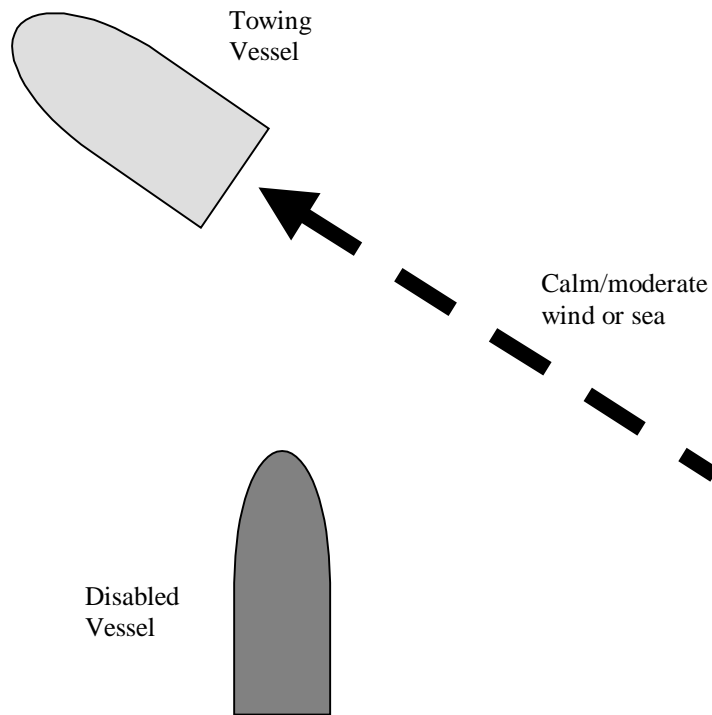

3. Crossing the "T" Approach. The crossing the "T" approach is used when there is a heavy sea or when the disabled boat's rate of drift is rapid. The towing boat crosses the bow of the disabled boat on a heading perpendicular to the disabled boat's direction of drift. This heading should be into the sea or wind, if possible. The towline is passed just before the towing boat's stern passes the disabled boat's bow.

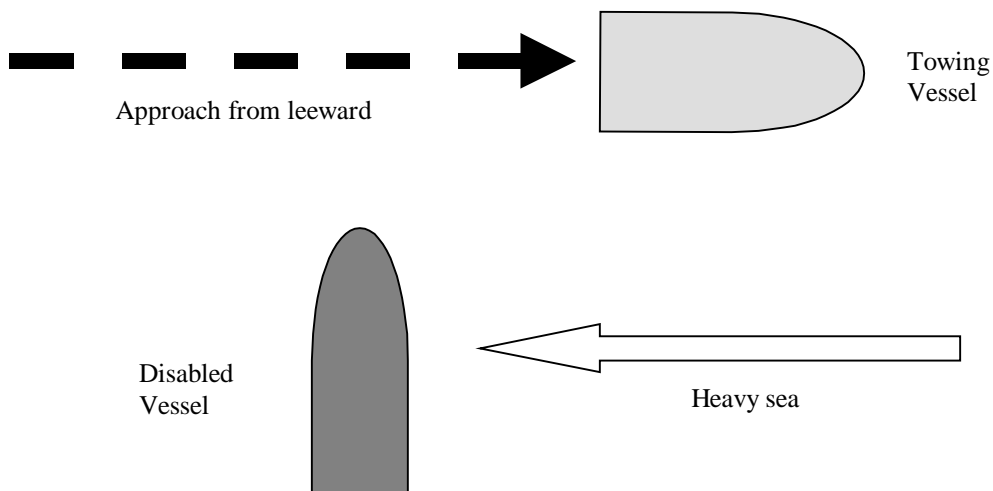

4. Back down Approach. Because of the construction and handling characteristics of some rescue vessels, the back down approach may be best to use when making an approach to a disabled vessel. However, caution must be exercised when using this approach because of the likelihood of backing down on your towline and getting it caught in the propellers. The towing boat backs slowly into the wind on the

windward side of the disabled vessel. Skilled boat handling is necessary at this point because the towing boat must pass close enough to pass the towline, reverse direction into forward, and stop a short distance ahead of the disabled boat. The towline is passed as the stern of the towing boat reaches the bow of the disabled boat.

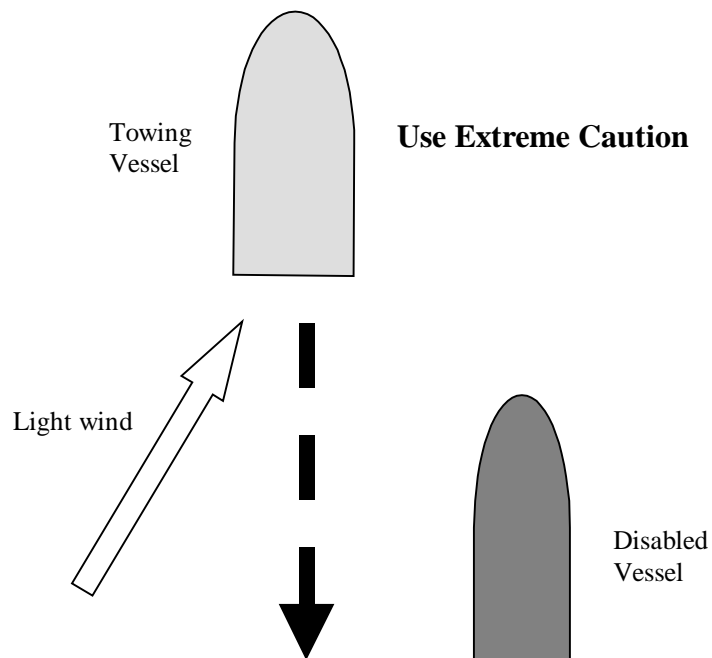

B. Hooking up to the disabled vessel.

1. If the bow eye is easily accessible, pass or throw the towline to the disabled vessel's operator and have them hook the towline into the bow eye.

2. If the bow eye is hard to reach, instruct your crew member to hook up, while being careful to avoid being pinched under the disabled vessel's bow.

3. Your crew can use a "kicker hook" to make the job of hooking the towline to the bow eye safer and easier.

4. If a bow eye is not accessible or available, you may need to put a crew member on board the disabled vessel in order to set up a special rigging using bow cleats. Be careful of weak bow cleats! Rig as a reversed "Y" bridle with the "Y" section being at least 3 times the width of the disabled vessel.

V. Responsibility for towing. The unwritten law of the sea states that all vessels will render assistance to any vessel in distress.

A. Protect life first, and property second.

B. When to tow.

1. If an immediate threat to life or property exists.
2. If equipment, skill level, and environmental conditions warrant that a safe tow can be made.

C. When not to tow.

1. You should not tow if the disabled vessel is sinking, on fire, or is somehow a danger to other vessels. In this type of situation, rescue the passengers and disregard the disabled vessel.

2. You should not tow if there is any doubt about safety due to equipment, weather, or skill level of participants.

a. Rescue passengers if there is a life threatening situation.

b. Try and obtain assistance capable of handling the situation.

3. You should not tow if the tow is only for the personal convenience of the disabled vessel.

4. You should not tow if a competent and willing towing service (commercial or volunteer) is immediately available.

D. Tow disabled vessels only to the nearest safe anchorage, harbor, marina, etc.

E. Liability is a double-edged sword when helping the public.

1. You could be held liable if improper procedures by you result in damage, injury, or death.
2. You could also be held liable if your inaction results in damage, injury, or death.

3. You should follow all procedures established by your specific agency and project. Courts may recognize the following of established policy and procedures as a sign of competency and good faith effort.

VI. Anchoring

Even though anchors are used most often by recreational boaters to “park” their boat while swimming, fishing, etc., anchors are also critical equipment in times of emergency. Anchoring may be a safety measure if your boat becomes disabled.

A. Choose an anchor that fits your boat and boating conditions

- The fluke style anchor (commonly referred to as Danforth) is similar to a plow style but is more lightweight. It is a good choice for most boats and gets its holding power from its pointed flukes digging into the bottom sediments.
- The mushroom anchor gets its holding power by sinking onto the bottom sediments. You should never depend on a mushroom anchor to hold your boat in rough water or weather. These anchors are only suitable for a silt or mud bottom, since they rely upon suction and cohesion of the bottom material, which rocky or coarse sand bottoms lack. The holding power of this anchor is at best about twice its weight until it becomes buried, when it can be as much as ten times its weight. They are available in sizes from about 10 lbs. up to several tons.
- The plow style anchor is good for most boats and gets its holding power by plowing into bottom sediments. Ploughs are popular with cruising sailors and other private boaters. They are generally good in all bottoms, but not exceptional in any. Plough anchors are usually stowed in a roller at the bow. Owing to the use of lead or other dedicated tip-weight, the plough is heavier than average for the amount of resistance developed, and may take more careful technique and a longer period to set thoroughly.



B. Prepare your anchor before setting out.

- Attach 10-15 feet of galvanized chain to the anchor. The chain aids in setting the anchor by lowering the angle of the pull as the chain sinks and lies on the bottom. It will also help prevent abrasion of the anchor line from sand or rock on the bottom. The size of the chain should be one-half (1/2) the size of the diameter of the anchor line.
- Be sure the anchor line is strong and long enough to anchor your boat. Both three-strand and braided nylon ropes make excellent anchor rodes. The anchor rode is the line and/or chain that connects to the anchor. Three-strand gives greater elasticity at lower cost, but braided nylon is more flexible. A good rule of thumb is 1/8" of line diameter for every 9 feet of boat length. In other words, if you have a 26-foot boat, you need 3/8" line. A good rule of thumb is that the length of the anchor line should be seven to ten (7-10) times the depth of the water plus freeboard.
- Since an anchor can be a safety device, store the anchor and lines in an accessible area. If the engine breaks down you may need to deploy it quickly to avoid drifting aground or running into another boat or fixed structure.

C. Steps to anchor your boat.

- Check the bottom characteristics to determine that you are anchoring in a safe and allowable place. If there are rocks, shoals, reefs or other boats to consider, give them all as wide a berth as possible. Remember that other boats will often have different requirements for anchor rode length--larger or taller boats frequently need a great deal of rode. Also, keep in mind a possible swing of 360 degrees about the anchor with wind shifts or current changes.

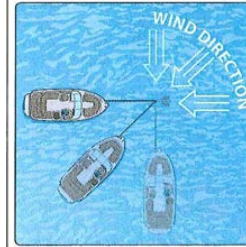

- Head into the wind or current. Reduce speed and reverse the engine. When the boat starts to make a slight sternway through the water, lower - do not throw - the anchor. Never anchor from the stern as this can cause a boat to swamp.
- After you've let about a third of your line out, tug the anchor line to see how firmly it's set, and then continue to release the rode. Let out about **7-10 times** as much anchor line as the depth of the water and tie off around a bow cleat.
- It's a good idea to take two immediate bearings. Select two items, one off each beam, that form a natural range and watch for any changes in their relationship. You can check these later to determine if you're boat is swinging as expected or if you're dragging anchor.



D. Steps to retrieve your anchor.

- Move the boat directly over the anchor while pulling in the line. Pulling the anchor straight up should break it free.
- If the anchor is stuck, turn the boat in a large circle while keeping the anchor line tight.
- When the anchor breaks loose, stop the boat and retrieve the anchor. Never drag the anchor behind the boat.

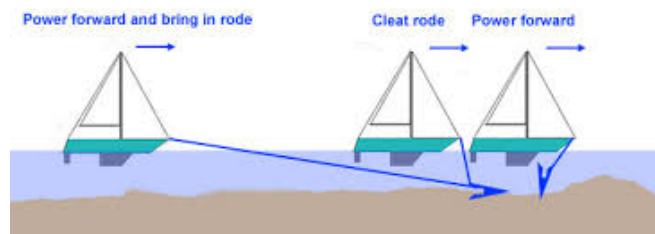

TAB 12
24 HR. MOTORBOAT OPERATOR COURSE
EVALUATION SHEET

24-hour Motorboat Operator Training Manual

1. Overall, how would you rate the Motorboat Operator Course in terms of its value as a training course to perform your job?

_____ Excellent _____ Very Good _____ Good _____ Fair _____ Poor

2. Please rate the following classroom aspects of the course:

	Excellent	Very Good	Good	Fair	Poor
Boat & Boat Maintenance	_____	_____	_____	_____	_____
Boat Orientation	_____	_____	_____	_____	_____
Trailer/Trailer Maintenance	_____	_____	_____	_____	_____
Rules of the Road/Aids to Navigation	_____	_____	_____	_____	_____
Required Safety Equipment	_____	_____	_____	_____	_____
Fire Suppression	_____	_____	_____	_____	_____

3. Please rate the following practical aspects of the course:

	Excellent	Very Good	Good	Fair	Poor
Trailer/Trailer	_____	_____	_____	_____	_____
Launching	_____	_____	_____	_____	_____
Docking	_____	_____	_____	_____	_____
Marlinespike	_____	_____	_____	_____	_____
Maneuvering Course	_____	_____	_____	_____	_____
Towing & Emergency Procedures	_____	_____	_____	_____	_____

4. What is the single most important thing you have gained from taking this course?

5. Which part(s) of the course did you get the most out of (and why)?

6. Which part(s) of the course did you get the least out of (and why)?

7. Please provide your suggestions, comments and how we can improve the course: